



ADIABATIC DUCT TYPE
HUMIDIFIER H200, H250



EN USER AND INSTALLATION MANUAL

TABLE OF CONTENTS

1. SAFETY REQUIREMENTS FOR THE USER	4
2. DELIVERY CONTENT	5
3. OPERATING PRINCIPLE AND SAFETY FUNCTIONS	6
4. DESCRIPTION OF THE HUMON HUMIDIFIER	7
5. SPECIFICATION	8
6. INSTALLATION	9
7. MAINTENANCE	15
8. CASSETTE REPLACEMENT INSTRUCTION	16
9. SERVICE	17
10. CONTROL SYSTEM	18
11. DIAGRAM OF THE HUMIDIFIER OPERATING PRINCIPLE	24
12. TROUBLESHOOTING	25
13. WIRING DIAGRAM	27
14. DECLARATION OF CONFORMITY	28
15. TECHNICAL PARAMETERS FOR THE INSTALLATION OF THE HUMIDIFIER	29



This symbol on the device indicates that electrical and electronic products should not be discarded as unsorted household waste. Electrical and electronic waste must be delivered to designated collection centres and waste acceptance facilities for recovery and recycling. Improper handling of this type of waste could have a negative impact on the environment and human health due to potentially hazardous substances. At the same time, your cooperation in the correct disposal of this product will contribute to the effective usage of natural resources and help avoid negative consequences for the environment and human health.

1. SAFETY REQUIREMENTS FOR THE USER



To avoid the risk of fire, electric shock, or injury, read all the safety instructions and warning texts before using the humidifier.

All electrical connections must be carried out by qualified electricians. If the power lead is damaged, it must be replaced by the manufacturer,

the manufacturer's service agent or a similarly qualified person. It is the installer's responsibility to carry out a complete safety and function assessment of the device.

This device may be used by children of 12 years or above or by persons with reduced sensory capacity or reduced physical or mental capacity, or by persons lacking experience or knowledge, provided that they have received instructions for safe use of the appliance or are supervised to ensure safe use, and provided that they are aware of the risks.

The device is not suitable for use by children. Children must not be allowed to play with the device. Children must not carry out cleaning or maintenance without supervision.

This humidifier is only designed for humidity control in ventilation air in dwelling houses and commercial buildings. To maintain a good indoor climate, comply with regulations, the device must never be switched off apart from during service/maintenance or in the event of an emergency.

The device should be operated with drinking water and sewage drainage connections. All plumbing work must be carried out by an authorised plumber.

The electrical equipment is tested, connected and grounded in accordance with CE regulations. The device must be plugged in to an electrical outlet that is earthed, in good order and corresponds with all requirements of electric safety.









2. DELIVERY CONTENT

The HUMON humidifier should be examined upon receipt to ensure that no visible damage has occurred during transport. If the device is not to be installed immediately, it should be stored in a clean, dry area in the original packaging. Before installing the HUMON humidifier, make sure that the device is complete and undamaged.

The following components are supplied:



Humidifier

	<p>1 x water supply hose (L = 1.5 m; Ø 4 mm; two-piece adapter from 4 mm to 3/8" BSP connection);</p>
	<p>1 x cable with a computer connector for the mains plug (L = 1 m);</p>
	<p>1 x touch-type control panel with a cable and USB connection (L = 5 m);</p>
	<p>1 x combined humidity-temperature sensor T1/RH for connection to a supply air duct (L = 2 m);</p>
	<p>1 x combined humidity-temperature sensor T4/RH4 for connection to an extract air duct (L = 2 m);</p>
	<p>1 x temperature sensor T3 for measuring the outdoor air temperature (L = 2 m),</p>
	<p>1 x water drain hose (L = 3 m; Ø 16 mm) with an adapter and a metal clamp;</p>
	<p>1 x connection cable with a coupling to the mains socket (230 VAC; L = 1 m).</p>

3. OPERATING PRINCIPLE AND SAFETY FUNCTIONS

HUMON is an adiabatic humidifier intended for humidification via a ventilation duct system of small and medium-sized spaces, such as family houses, flats, and offices.

The purpose of the HUMON duct-type adiabatic humidifier is to ensure continuous humidification of supply air in the ventilation system under pre-defined parameters. The air passing through the evaporating material becomes more moisturised and slightly cooled due to the adiabatic humidification process.

The device must be installed in the air supply duct of the ventilation system inside the building. The installation premise must be equipped with a power supply, fresh water connection, and wastewater trap.

The humidifier operates completely independently and switches on when the (absolute) outdoor air humidity becomes too low, the air flow is detected and the temperature of the inlet air before the humidifier is more than 14°C.

The device must be switched on in standby mode to continuously monitor air parameters and start the humidification process on time.

The device can be used in any balanced ventilation system.

The switching of the device is linked to the outdoor temperature. This value is controlled by the temperature sensor T3 that must be installed in the outdoor air duct. The default temperature setting for triggering the HUMON device is 12°C. It can be changed in the settings, considering the prevailing outdoor temperature, the regional humidity, and the type of HRV unit used in the ventilation system.

the maximum value. The humidification intensity depends on the outdoor air temperature and humidity in the supply duct after the HRV unit. The relative humidity can be additionally raised up to 30% in the supply air.

This additional moisturisation depends on the inlet temperature, air amount, relative humidity, and outdoor air temperature.

The integrated PTC air preheater operates when the air temperature is lower than the set-point. If the supply air temperature is set below the inlet temperature, the preheater will use less energy.

The maximum moisture supply capacity depends on the air temperature, humidity and airflow across the humidifier.

The device contains heating elements that must not be touched when hot. Before opening the door, the device must be switched off for at least 1 minute.



In case of a power failure, the humidifier will not start automatically after the power has been restored. To start the device, touch the screen (see page 21, Table 4).

Safety

Built-in PTC air preheater has all the advantages of PTC heating technology. Thanks to the PTC effect, the heating elements dynamically adjust their power without exceeding a maximum temperature. A mechanical temperature thermal protector switches the PTC preheater off if permissible safety temperature is exceeded.

A built-in additional temperature sensor inside the humidifier switches off the PTC preheater if the hazardous temperature is exceeded.

The integrated water filter in the HUMON humidifier cleans the water, removing Legionella bacteria. The supply water enters the evaporative media already purified. The HUMON water filter uses ultrafiltration technology, which is based on pressure-driven membrane technology, to remove (colloidal) particles, sediment, turbidity, bacteria, and viruses. The efficiency of reducing bacteria with the ultrafiltration process is 99.9999% (Log 6). With ultrafiltration, all dirt particles, bacteria, and viruses are filtered, reducing biofilm growth. The final product



It is recommended to keep HUMON device in standby mode all the time, as it includes several features to maintain the removal of bacteria from water and air. Besides, the humidifier switches on automatically, upon reaching the default parameters set for the outdoor air temperature or indoor relative humidity. Thus, a good indoor climate and a hygienic operation of the device will be maintained.

Subject to certain conditions, the HUMON device humidifies the supplied air up to the relative humidity of 75%. The desired humidity is set by the user, not exceeding

of ultrafiltration is clean and safe. Only fresh water can be used. No water is recycled inside the humidifier. The evaporative media is completely dry if there is no demand for humidification.

The combined humidity-temperature sensor T1/RH1 is used to measure the relative humidity and temperature in the supply duct after the HUMON device. It helps to achieve the best operation algorithm to prevent condensate formation in the ducts under normal conditions of use.

Anti-legionella protection. When the air humidifier is in

standby mode, the water valve will automatically open every 72 hours and flush the humidifier pipes for 1 minute to prevent Legionella from occurring.

The water valve is protected against dirt with an inside mechanical filter.

An air purification device—a bipolar ionisation device—is located after the evaporative media to clean the air from viruses and bacteria. The bipolar ionisation device neutralises odours, destroys VOCs, kills pathogens (bacteria, viruses, moulds), and helps to control allergens.

4. DESCRIPTION OF THE HUMON HUMIDIFIER

Housing

The housing of the HUMON humidifier is made of aluminium zinc-coated steel sheets (reaction to fire class A1 class, surface corrosion class C4-M/C3-H). The humidifier door is easily accessible from the front, and all external sensors and components are connected via external connectors. The control PCB board, water valve and cassette with water filter and evaporative media are located inside the device, behind the door. The humidifier must be connected to the ventilation system via two external duct connectors.

Internal construction

The internal construction has been developed to minimise internal pressure drop, providing good humidification. A cassette is fitted inside the HUMON humidifier, containing the water filter and evaporative media. The supply water passes through the filter before being applied to the evaporative media. The supplied air passes through the evaporative media. Humidifying occurs through contact between the passing air and the wet media surface. Surplus water is drained. The humidified air then passes through the bipolar ionisation device and enters the supply duct. The PTC preheater is only operational when the supply air temperature falls below the pre-set minimum temperature.

Combined humidity-temperature sensors (T1 and T4)

The supply duct sensor T1/RH1 and the extract duct sensor T4/RH4 measure the relative humidity and temperature in the ducts. T1/RH1 must be installed in the supply air duct after the HUMON device, and T4/RH4 must be installed in the extract air duct from the treated rooms before the HRV unit. These sensors measure and control indoor humidity and temperature.

Temperature sensor (T3)

T3 is an NTC-type temperature sensor to be installed in the intake air duct between the outdoor air intake and the HRV unit. This sensor determines when the HUMON humidifier must be switched on or off.

Bipolar ionisation device

The ionisation device remains switched on continuously if the HUMON humidifier is in operation mode. The ion generator creates negative and positive ions to maintain a clean and fresh air supply with significantly less viruses and bacteria.

Touch-type control panel

The HUMON humidifier is equipped with a wired control panel. It is used to set all the required parameters: the humidity and temperature in the supply duct, the desired humidity in the room to be reached, and the outdoor air temperature triggering the device. The control panel also displays sensor readings, alarms and service needs.

5. SPECIFICATION

HUMON humidifier scheme

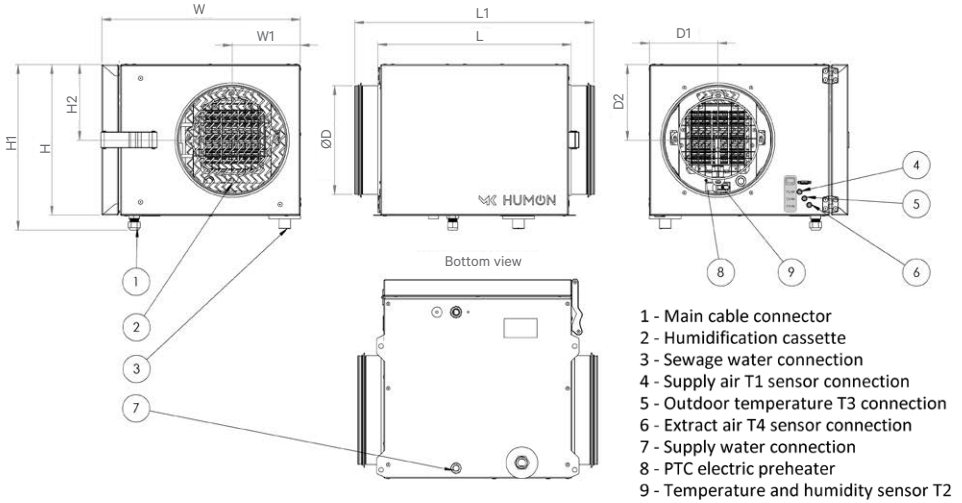

	W	H	W1	H1	H2	ØD	L	L1	D1	D2
200	363	275	125	302	138	200	354	440	125	138
250	415	345	150	370	170	250	354	440	150	170

Table 1. Technical data

Description	Parameters	
Dimensions WxHxL	363 x 275 x 354 mm	415 x 345 x 354 mm
Air duct connections	Ø200 mm	Ø250 mm
Humidification capacity	0 – 3,2 l/h	0 – 4,8 l/h
Rated voltage/frequency	230 V / 50 Hz	230 V / 50 Hz
Rated current	8,1 A	12,1 A
Rated power, total	1100 W	1400 W
Average annual consumption	100–800 kWh (depending on set points)	500-1200 kWh (depending on set points)
Maximum water consumption	5–7 l/h (depending on set points)	5–9 l/h (depending on set points)
Water supply connection	¾ internal thread with a connection to a 4 mm tube	¾ internal thread with a connection to a 4 mm tube
Water drain tray connection	½ thread adapter to the 16 mm spiral drainage tube	½ thread adapter to the 16 mm spiral drainage tube
Operating air volume	80–500 m³/h	80 – 700 m³/h
Device weight	9,5 kg	11,7 kg
Water quality	Hardness < 9 dGH, TDS < 350 ppm	Hardness <9dGH, TDS <350ppm

6. INSTALLATION

Depending on the air duct connections, the right or left side must be selected for the humidifier inspection.

Left inspection side: look at the humidifier door – the air passes from right to left. The sensor connectors are located on the right side, on the side wall near the hinges.

Right side inspection: look at the humidifier door – the air passes from left to right. The sensor connectors are located on the left side, on the side wall near the hinges.

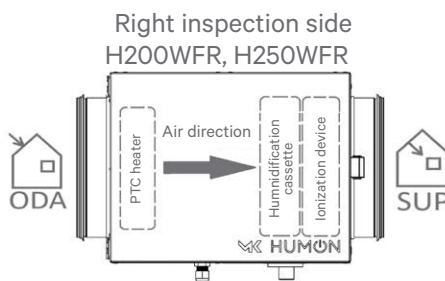
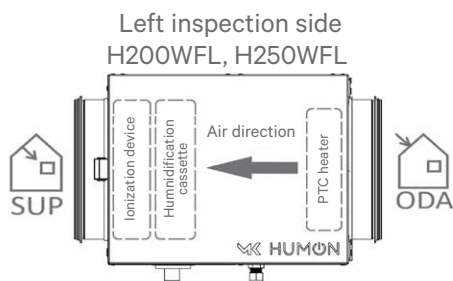

Fig. 1. The inspection side of the humidifier



The positioning of the HUMON device must comply with the electrical safety legislation of the individual countries. Check what rules apply in your country.

The device should be installed with an earth fault breaker. All electrical connections must be carried out by a qualified electrician.

It is important for the main plug to be accessible for servicing when the device is fully installed.

A **type E** plug must be provided.

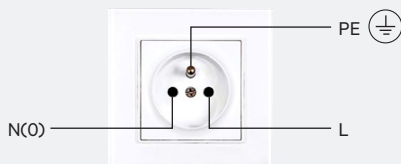

The HUMON humidifier must be installed in the supply air duct as close as possible to the HRV unit. The minimum distance to the available bends is 200 mm.

The HUMON device must be installed with suitable space for servicing and maintenance, such as replacing the humidifier cassette and cleaning the drain tray and the ion generator. See Fig. 2 for the minimum requirements; note that they only consider service needs.

All electrical parts of the device must be easily accessible when the HUMON humidifier is fully installed.



Shortening or lengthening of the water supply hose (Ø 4 mm) is forbidden! It must remain at the factory length of 1.5 m.

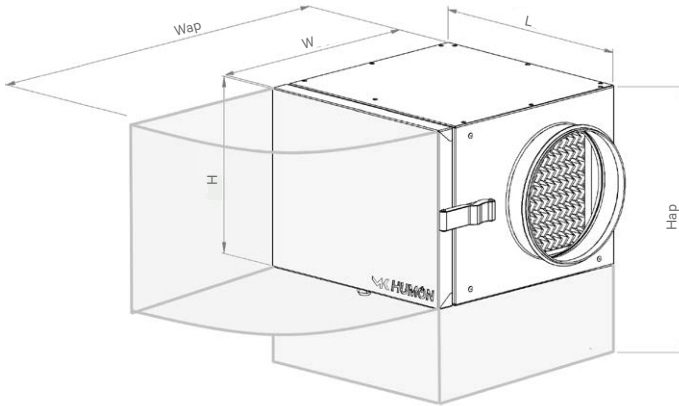

Fig. 2. Recommended maintenance area

	W	L	H	Wap	Hap
200	363	354	275	720	400
250	415	354	345	770	480

Signal cables must be at least 10 cm away from the power cables and should not be laid together during installation.

Keep at least 130 mm clear space at the bottom of the device and 360 mm in front of the device for the door opening and servicing.

Install the HUMON device horizontally in the duct system. The humidifier must be hung perfectly levelled to guarantee good water drainage (see Fig. 3). A slight slope can be left towards the water outlet for complete drainage (there is also a slope for drainage inside the drain tray).



The HUMON humidifier must be installed perfectly levelled, which is important because of the drain tray inside the device.

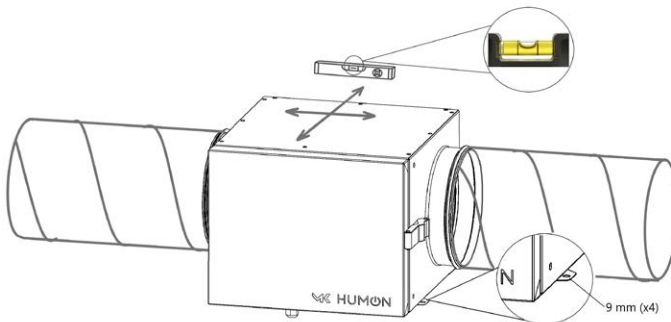

Fig. 3 Installed and levelled HUMON humidifier

The humidifier housing is equipped with fastening holes suitable for fastening the device to different brackets. It can also be attached to M8 studs. Before screwing in the humidifier housing, level it correctly so that the water in the drain tray runs out through the outlet. Only then connect the ventilation ducts.

Connect the black 4 mm hose connection with the 3/8" adapter to the mains water supply using a 3/8" water connection tap with a filter inside.

Make sure that the water pressure in the system is from 1,5 to 2,5 bar.

The HUMON humidifier is supplied with a 16 mm drain hose with a length of 3 m. Other drain hose lengths can be ordered. See Fig. 5 and 6 for installation examples. Do not use tools to screw the water connection to the drain tray nozzle; only use your hands for this (wear gloves).

Install the temperature and humidity sensor T1/TH1 into the air supply duct as closely as possible after the HUMON humidifier. The recommended distance from the humidifier is 150–1,000 mm. Insert the plug of the T1/TH1 sensor into the T1/RH1 socket on the humidifier housing.

Install the temperature and humidity sensor T4/RH4 into the air extract duct up to the HRV unit. The sensor must receive the correct extract air data. Insert the plug of the T4/TH1 sensor into the T4/RH1 socket on the humidifier housing.

The temperature sensor T3 must be installed in the duct of the air entering the system from the outside. Only after the T3 sensor has read the correct outdoor air temperature data can the desired air humidification parameters be set. Insert the plug of the T3 sensor into the T3 socket on the humidifier housing.

Mount the control panel on the wall or other surfaces near the humidifier. Insert the control panel plug into the USB socket on the humidifier housing.

Insert the main plug into the socket. Check the voltage. The control panel should switch on. Wait 5 seconds and touch the screen to start using it. After 5 minutes, briefly open the door. The green power LED must switch on. This means the humidifier works well.

Each time the device is switched on, the PTC heater is automatically activated for 30 seconds, and the water valve is opened for 60 seconds. The sensors must start reading the temperature and humidity changes. If no changes occur, the humidifier will be stopped with alarm readings after a specific time, and the fault will be displayed in the service menu list. Try switching the humidifier off and on again from the main power supply.

After 2 minutes of the test run, check the entire system for any water supply or drainage system problems.

After 1 hour, recheck the entire system for leaks in the water supply tubing and drainage system.

The drain hose must be connected to the sewage drainage. The system must be open-type, depressurized and sufficiently lowered to allow the water to flow out of the drain tray.



All condensate drain connections must be correctly installed. Incorrect trapping of the waste water can result in flooding within the humidifier drain tray and consequent flooding of the immediate indoor area.

The drainage system must not be connected directly to the municipal waste water system.

In case of a power failure, the humidifier will not start automatically after the power has been restored. To start the device, touch the screen (see page 21, Table 4).



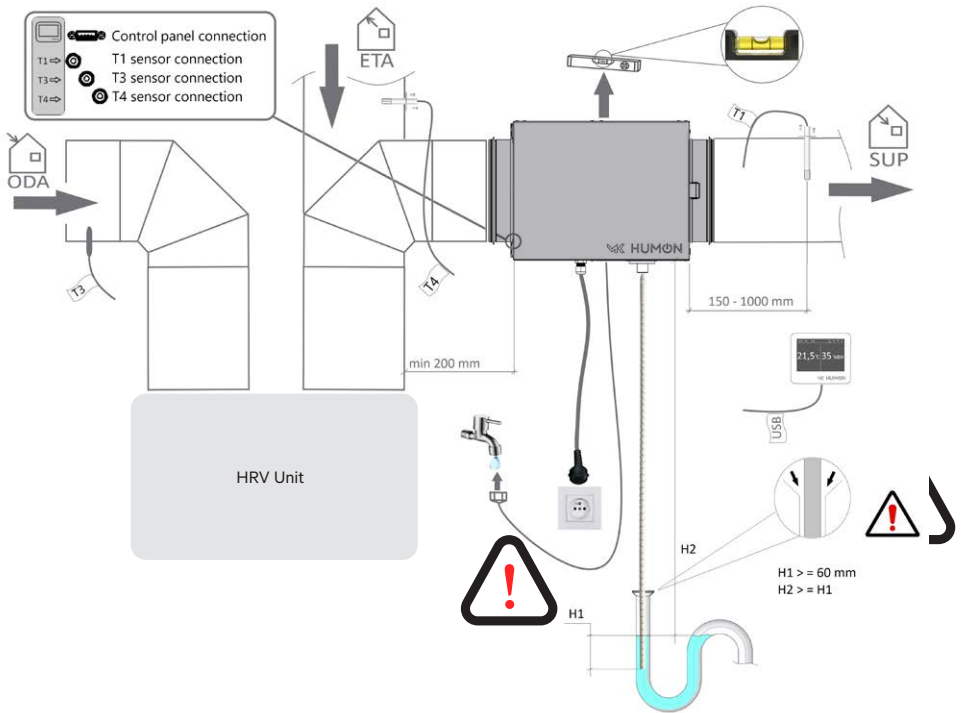

Fig. 4. HUMON humidifier installation scheme



Fig. 4.1. Connecting the air ducts and fittings to the humidifier (it is forbidden to screw the self-tapping screws on the horizontal and vertical axes – this may

damage the internal parts of the humidifier; the self-tapping screws must be screwed in at a 45-degree angle from the horizontal and vertical axes)

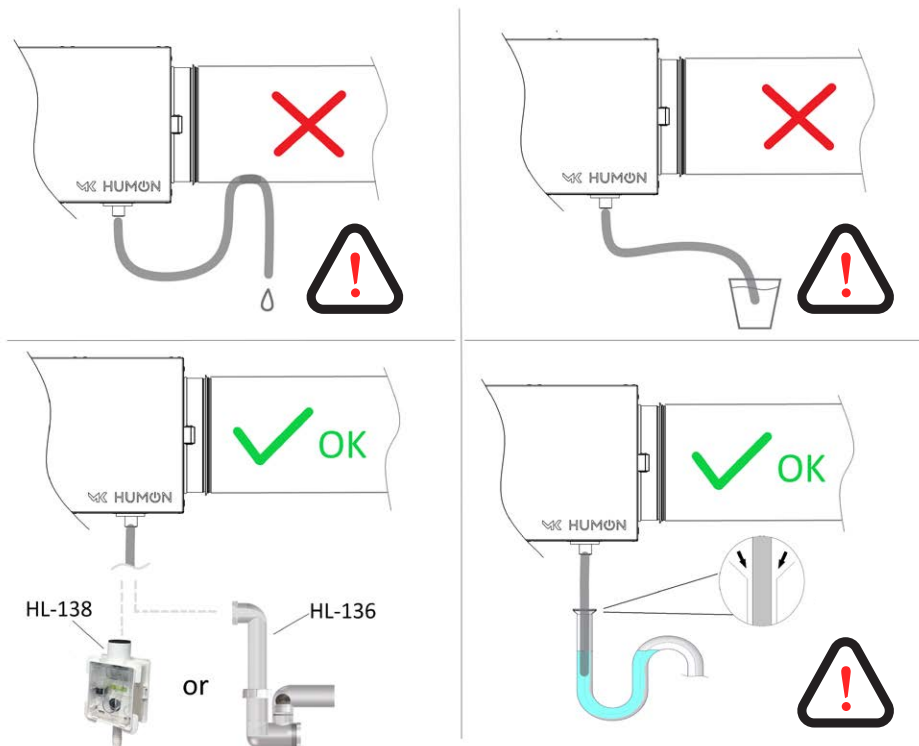

Fig. 5. Drainage installation schemes



Do not use any tools to fasten the water connector, do it by hands only.

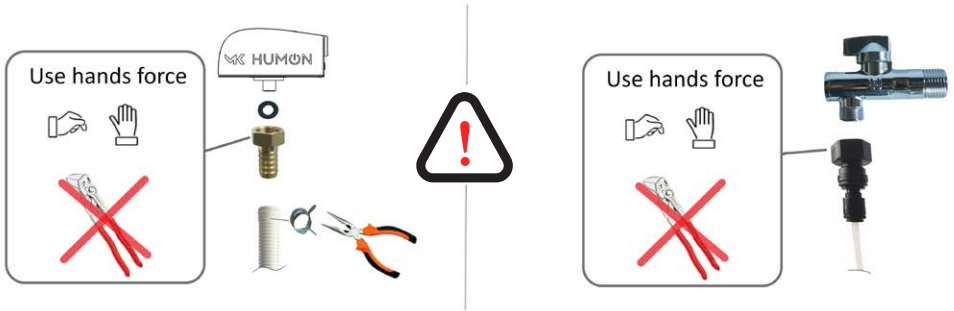

Fig. 6. Water connection scheme



Do not use any tools to fasten the water connector, do it by hands only.



Shortening or lengthening of the water supply hose (Ø 4 mm) is forbidden! It must remain at the factory length of 1.5 m.

7. MAINTENANCE

After the installation of the HUMON device, an overall inspection should be carried out. This should include inspecting the inside of the device and removing debris and tools which on-site contractors may have left behind, a sensor connection check, a water supply tubing check and a drain hose installation check. Close the door, ensuring that the door sealing gaskets have not been damaged after installation.

It is recommended to carry out routine maintenance of the HUMON device 2–3 times per year at the beginning and end of the autumn/winter season.



Before performing any inspection work, make sure that the device is unplugged from the electric power supply.

Checking the preheater

Check that the PTC heater is clean and that the heating element is not clogged. Clean the heater and pump if necessary. Before checking the PTC, it is necessary to remove the evaporation cassette. Note: first, disconnect the water supply tube. (See the CASSETTE REPLACEMENT INSTRUCTION).

Checking the air ion generator

The ion generator needs to be thoroughly cleaned of dust, as dust can reduce the amount of ions produced in the air. Use a soft brush. Do not use water! Do not bend or break the generator carbon brush! Before checking the generator, it is necessary to remove the evaporation

cassette. Note: first, disconnect the water supply tube. (See the CASSETTE REPLACEMENT INSTRUCTION).

Checking the evaporation cassette

The evaporation media must not be cleaned! The cassette must be replaced if the RH% measured by the air duct sensor T1/RH1 does not rise above 45 % for a prolonged period. The service alarm will be shown on the control panel display after a specific time, based on the number of valve opening cycles. The service life of the media depends on the amount of dissolved minerals in the water (the water hardness indicates this). If the water hardness is higher than 9 dGH, the service life will be shorter than the standard one. During the cassette replacement process, it is necessary to check and clean the drain tray and the connection hose. The cassette holder is removable from the drain tray

and the tray is cleaned with a wet cloth or a soft brush, using soap or another stainless steel cleaner (be careful with solvents that can damage the drain hose).

The HUMON water filter is located inside the cassette. Its service time is determined based on the amount of sediments in the water. The service indication is valid for water with a TDS value of less than 350 ppm. You can learn about your area's water quality by taking a water quality test at the relevant water testing laboratory. If its TDS value is higher than 350 ppm, installing a sediment filter or a reverse osmosis water filter is recommended.

The estimated service time is shorter if the water values are higher than in Table 1 in Chapter 5.

The HUMON cassette must be replaced at least every 3 years or when the service indication appears on display. If only the evaporating media needs to be replaced, it can be replaced separately.

An informative service message that reminds you to perform device maintenance will pop up on the control panel each year at October 1st.(alarm code No. 25).

8. CASSETTE REPLACEMENT INSTRUCTION

- Unplug the HUMON humidifier from the main supply socket.
- Disconnect the water supply.
- Open the humidifier door.
- See Fig. 7. Disconnect the cassette from the water supply by pushing the clamp on the water supply connector and pulling the hose simultaneously.
- Pull out the cassette from the HUMON humidifier using the integrated handle. Beware of any water leakage from the internal cassette components.
- Clean the inside of the HUMON humidifier with a wet cloth if necessary. Be careful when cleaning near the ion generator.
- Clean the drain tray by first removing the internal cassette holding element. Check that the drainage outlet is clean.
- Insert a new cassette or remove the housing screws with a screwdriver and replace only the evaporating media.
- Push in a new cassette to the back wall.
- Connect the water pipe to the water supply connection in reverse order to the one shown in Fig. 7.
- Close the door and open the water supply valve.
- Insert the plug into the socket. The HUMON humidifier must start filling the new filter with water and check all the sensors. After 1 minute, the HUMON humidifier is ready to operate. Follow the steps for starting and checking the humidifier as described in Chapter 6 'Installation'.



Replacing the cassette requires specific knowledge. Contact an installer in case of any doubts about replacing the cassette.

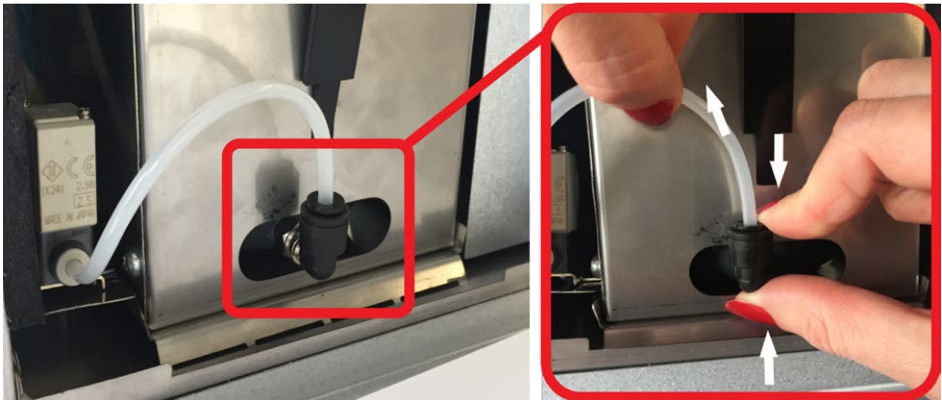

Fig. 7 Water tube disconnecting scheme

9. SERVICE

Table 2. A list of the HUMON humidifier spare parts

Ref. No	Description	Product code for ordering H200	Product code for ordering H250
1	HUMON cassette set with the water filter	DRK20101 (WFR), DRK201011 (WFL)	DRK25101 (WFR), DRK251011 (WFL)
2	HUMON humidification media	700022	700025
3	HUMON water filter set	70006	70006
4	PTC heater with connectors and brackets	DRK20104 (WFR), DRK201041 (WFL)	DRK25104 WFR, DRK251041 WFL
5	PTC heater	70023	700231
6	Water valve set with wires	VOZTVDW12	VOZTVDW12
7	Ion generator with the connector	70021	70021
8	T1/RH1 temperature and humidity sensor	70030	70030
9	T4/RH4 temperature and humidity sensor	70033	70033
10	T3 outdoor air sensor	70032	70032
11	MK HUMON control panel	70029	70029
12	Main control PCB board	70028	70028
13	Internal T2/RH2 temperature and humidity sensor	70031	70031
14	Airflow sensor	70044	70044

An overview of the internal components of the HUMON humidifier

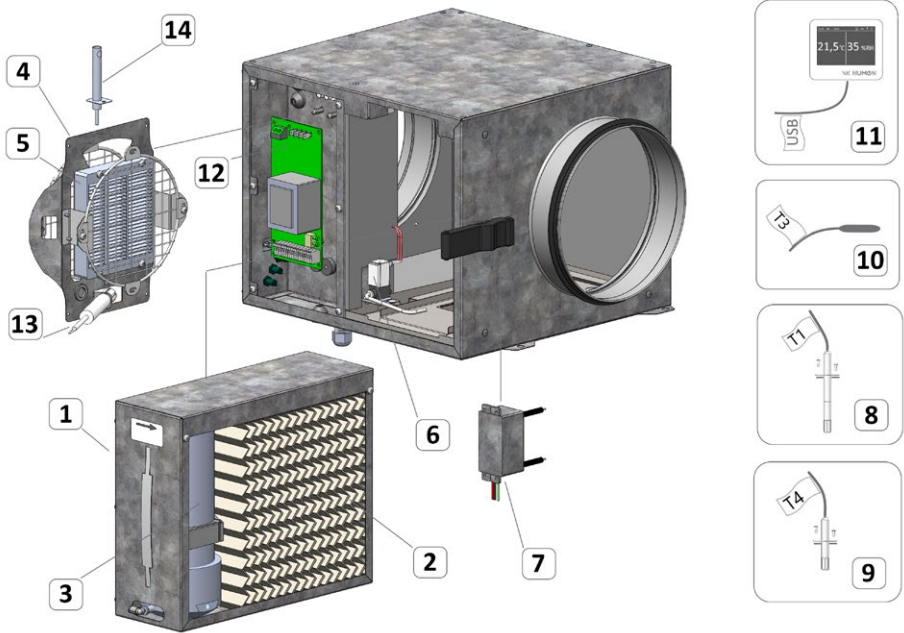

10. CONTROL SYSTEM

Control panel view

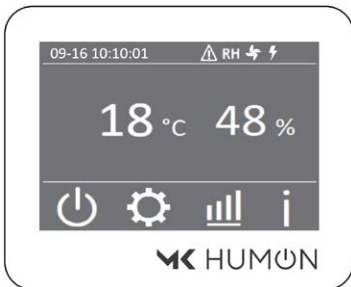

- During operation, the display in sleep mode always shows the actual supply air temperature and humidity. The information is provided for the T1 sensor data.
- You can see the temperature and humidity set-points and the main menu buttons for 5 seconds by touching the screen once

Table 3. Icons used on the control panel



































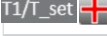

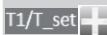





Icon	Description
	Humidifier off button
	Settings menu
	Live operation graph
	Service and fault list
	Confirmation button
	Cancel button
	Up and down selection buttons
	Temperature markers on all displays
	Humidity marker on all displays
	Back to the main menu button
	Error delete button in the service and fault list. This button reboots the controller but leaves the error displayed in the list
	Toggle the button for another display
	Advanced user internal menu selection buttons for the sensor calibration
	Time and date settings
	Advanced user-locked menu
	Error alert icon in the live operation graph and the service and fault list
	Temperature sensor calibration. Manual calibration of the sensor readings with a calibrated temperature probe using the comparison mode
	Deletion of errors and warnings from the controller and control panel. All data are deleted permanently
	Humidifier cassette replacement. After inserting a new cassette, the meter must be restarted. Click the icon to confirm the installation of the new cassette
	Supply water pressure settings in the locked menu
	Outdoor air temperature settings in the locked menu for triggering the humidifier
	Indoor humidity setting in the locked menu, allowing to set the desired humidity level to be reached in the room

Table 3. Icons used on the control panel

Icon	Description
	Temperature sensor T3 is deactivated. The humidifier start-up is triggered by the airflow sensor or by the external dry contact from a switch or the HRV unit
	Temperature sensor T4 is deactivated. The indoor humidity demand is not monitored
	T_set temperature maintenance based on the outflow temperature from the HRV unit is deactivated. The temperature set-point will be read from the main menu setting
	Temperature sensor T3 is activated. The outdoor air temperature triggers the humidifier start-up
	Temperature sensor T4 is activated. The indoor humidity demand is monitored based on the humidity settings in the advanced user-locked menu
	T_set temperature maintenance based on the outflow temperature from the HRV unit is activated. T1 will be maintained at the level of the outflow temperature from the HRV unit insofar as it is manageable by the heater power
	If a reverse osmosis filter is installed in the water supply line before the humidifier, the service time of the integrated water filter increases. If the osmosis filter is available, the RO button should be grey-white. If the osmosis filter is not available, it should be red
	Reset the factory settings
	Outdoor air temperature readings
	Indoor temperature readings
	Temperature sensors readings
	Temperature sensor error. The alarm will be displayed in the fault list. The date, time and fault code will be displayed on the control panel
	PTC heater demand. This icon indicates the actual electricity demand
	Humidification demand. This icon indicates the actual water demand
	Humidification process error. The alarm will be displayed in the fault list. The control panel will display the date, time and fault code. The icon will flash if an insufficient amount of supplied water is detected on evaporative media. The icon will light continuously when continuous water flow trough the valve is detected.
	Indoor sensor error. The alarm will be displayed in the fault list. The date, time and fault code will be displayed on the control panel
	Error or fault icon in the top data bar on the control panel display
	Humidification demand. This icon indicates that the humidification process is activated and running
	Airflow. This icon indicates that the airflow in the system is sufficient to operate the humidifier
	PTC heater demand. This icon indicates that the heater is activated and is running
	Communication error between the control panel and the control PCB board

Live operation graph display of the control panel

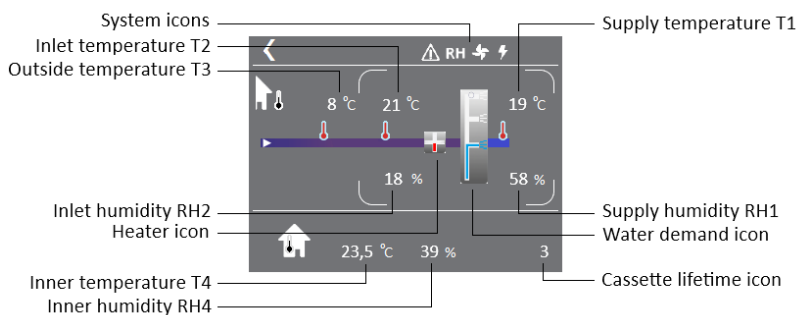

Table 4. Information on the control panel displays

Control panel display view	Action required
	<p>Starting the humidifier: click the screen with your finger. If the screen is in sleep mode, click the screen with your finger</p>
	<p>Display with the temperature and humidity settings</p> <ul style="list-style-type: none"> - Humidifier off button - Settings button - Live operation graph - Service and fault list <p>Click on the temperature and humidity set-points to change the settings</p>
	<p>Temperature setting</p> <p>Click on the temperature set-point up to a maximum of +30.</p> <p>Change the setting , and confirm </p>

Table 4. Information on the control panel displays











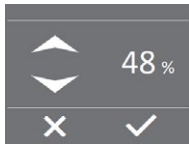

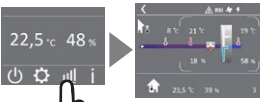

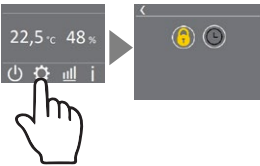
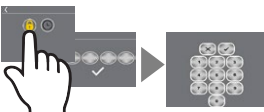
Control panel display view	Action required
	<p>Humidity setting</p> <p>Click on the humidity set-point up to a maximum of 75%.</p> <p>Change the setting , and confirm </p>
	<p>Operating graph</p> <p>The control panel display shows all the current temperature and humidity readings with active icons for the PTC heater and water consumption</p>
	<p>Durability of the humidifier cassette</p> <p>The cassette usage icon indicates the level of contamination of the water filter and evaporating media from 0 to 100%, where 0 stands for the absolutely clean cassette and 100 – for the most contaminated one. The calculation is based on the service life of the water valve. For more information, see Chapter 7 'Maintenance'.</p>
	<p>Settings menu</p> <p>Time and date settings and the advanced user menu</p>
	<p>Settings/advanced user menu</p> <p>The login code is 3971 Calibration of temperature sensors and a permanent deletion of the fault list are possible. The second display shows the factory settings for the system parameters</p>
	<p>Advanced menu</p> <ul style="list-style-type: none">  - Temperature sensor calibration range from -5.0 to +5.0  - Permanent deletion of the fault list  - Second menu display  - Reset the cassette service life. Click this icon after replacing the cassette with a new one

Table 4. Information on the control panel displays

Control panel display view	Action required
	<p>Advanced menu</p> <ul style="list-style-type: none"> - Water pressure in the system (1.5–2.5 bar) - Outdoor air temperature to trigger the indoor humidification - Indoor humidity setting. When the humidity set-point is reached, the humidifier will switch to standby mode <p>T4 T3 - Temperature sensor(s) activation. When the T3 and T4 sensors are not in use, the readings of these sensors must be disabled</p> <p>T4 T3 + + - Function activated/deactivated</p> <p>T1/T_set - If the function is activated, the temperature after the humidifier will be maintained as the humidifier inlet temperature insofar it is allowed by the maximum capacity of the PTC heater</p> <p>RO + - Reverse osmosis filter is deactivated</p> <p>RESET + - Factory settings reset</p>
	<p>Service and fault list</p> <p>If there are any faults in the device, the information about the fault can be obtained from the service and fault list. The date, time and fault code will be displayed (see Table 5)</p> <p> - Troubleshoot the controller fault. The humidifier will start working again; however, the fault information will remain on display for further action. To permanently delete the fault, go to the advanced menu.</p>
	<p>Switching off the humidifier</p> <p>Press the button , and confirm </p> <p>The humidifier can be switched off from the main supply directly.</p>

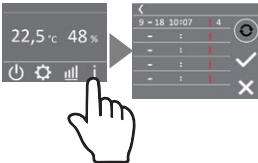
11. DIAGRAM OF THE HUMIDIFIER OPERATING PRINCIPLE

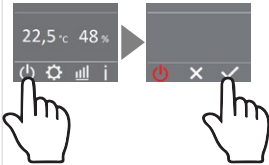
Depending on the set parameters, airflow, outdoor and indoor temperature and humidity, the controller continuously calculates the best possible water consumption at the closest humidity value in the air supply duct. For a better adiabatic process or a higher humidity level, the air needs to be preheated, which should be considered when selecting the humidification level of the supply duct.

There are four modes of the humidifier controller during the humidification process:

0 – the controller checks the opening cycles of the water valve and calculates the maximum water content; after a certain amount of time, the algorithm switches to mode 1.

1 – the controller calculates the humidity difference over time for a certain period; if no change in humidity is observed, the algorithm switches to a water-saving mode

2 – the controller activates the saving procedure and reduces water consumption to 0. The algorithm then switches to mode 3.

3 – the controller calculates the difference between the estimated and measured humidity. At specific steps, the algorithm switches to mode 0, and the whole process is repeated. The wavelength of the operating algorithm depends on the set parameters, outdoor and indoor temperature and humidity levels.

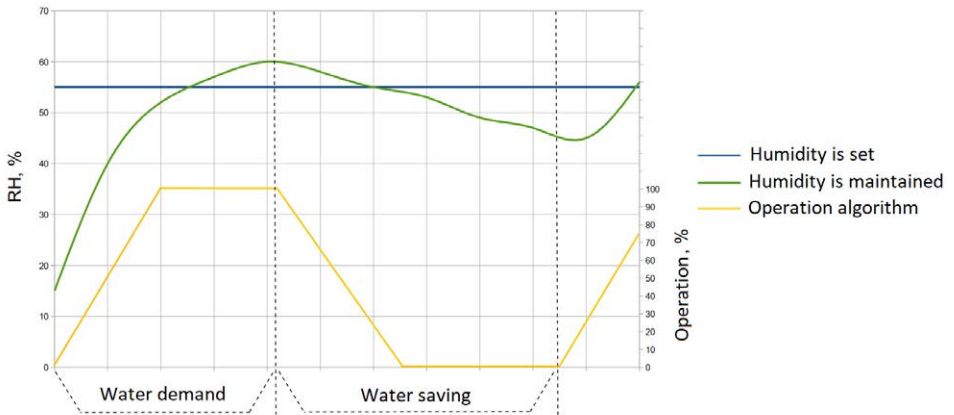

Fig. 8. Diagram of the operating principle

12. TROUBLESHOOTING

If the humidifier is not working:

- Make sure the humidifier is connected to the power supply.
- Check all sensor connections to the humidifier.
- If the control panel does not display anything, check whether the cable and connector between the control panel and the humidifier are correctly inserted. Make sure

there is no fault information in the live operation graph display of the control panel.



- Before the next step, the service and fault list on the control panel must be cleared to allow the controller to reboot.
- Follow the instructions in Table 5 to troubleshoot and clear the fault

Table 5. Alarm codes on the control panel, their causes and remedies

Fault code	Meaning	Possible remedy	Reset
1	T1/RH1 sensor fault, broken cable or disconnected from the connector	Check the sensor connector. Check the cable for damage; if in doubt, replace the sensor with a new one	Automatic
2	T2/RH2 sensor fault, broken cable or disconnected from the connector	Check the sensor connector. Check the cable for damage; if in doubt, replace the sensor with a new one	Automatic or manual
3	T3 sensor fault, broken cable or disconnected from the connector	Check the sensor connector. Check the cable for damage; if in doubt, replace the sensor with a new one. The sensor can be tested at 10°C in water or air. The humidifier must start working if other demand signals are active (air flow, external contact, if presents)	Automatic or manual
4	T4/RH4 sensor fault, broken cable or disconnected from the connector	Check the sensor connector. Check the cable for damage; if in doubt, replace the sensor with a new one	Automatic or manual
8	The PTC heater is not working	1) Check the airflow. The PTC heater may have switched off due to lack of air flow. If the air flow is OK, (2) switch off the humidifier and turn off the water tap. Let the evaporative media dry. After about 20 minutes, switch on the humidifier. The temperature after humidifier should start increasing slightly after 15 s (upon activation of the control panel); under certain conditions, it may be higher than the inlet temperature. If the temperature does not increase, contact the installer to have the PTC heater replaced.	Automatic

Table 5. Alarm codes on the control panel, their causes and remedies

Fault code	Meaning	Possible remedy	Reset
11	No water supply, water valve broken	Check that the water tap is open. If the tap is open and there is a demand (the outdoor temperature is below 12°C, the airflow icon is active, and the RH icon is active), check the filter within the tap for cleanness. Check the operation of the water valve. Open the door, and disconnect the white tube from the filter water connection bend. Reset the device by plugging the power cable out and in. If water flows from the valve and stops after 60 seconds, the valve works properly. If the water is flowing steadily or does not flow out of the tube at all, the water valve is damaged and must be replaced. If the water valve is working, but the evaporating media is dry after the valve is turned on, the water filter is clogged. If the evaporating media is still suitable, replace the cassette or the water filter. If the evaporating media gets wet but the humidification power is low, the media contains minerals and the cassette or the evaporating media must be replaced. The humidifier can continue to operate but with a lower evaporation efficiency	Automatic or manual, after replacing the cassette
13	No communication between the control panel and the controller 	Check the control panel wiring and the humidifier USB connection. Check the cable for damage. Check the LED indicator on the electrical cabinet under the door. The yellow LED should be permanently on while the green LED is flashing. If it does not work, contact the installer to have the cable, the control panel or the controller replaced	Manual
21	Ion generator fault	Delete the error and reboot the humidifier; if the fault happens again, contact the installer to have the generator replaced. The humidifier can continue to operate.	Automatic
22	Airflow sensor fault	Delete the error and reboot the humidifier; if the fault happens again, contact the installer to have the sensor replaced. The fault will be indicated, but the humidifier will continue to operate, requiring the user to switch the humidifier off/on manually.	Manual
23	Water valve fault*	Check the operation of the water valve. Open the door, and disconnect the white tube from the filter water connection bend. Reset the device by plugging the power cable out and in. If water flows from the valve and stops after 60 seconds, the valve works properly. If the water is flowing steadily, the water valve is damaged and must be replaced. Before the Service arrival we recommend to turn off the water supply.	Manual
25	Maintenance Notice	This is maintenance notification that appears each year on October 1st. It reminds to perform the steps in this USER AND INSTALLATION MANUAL in section 7. MAINTENANCE.	Manual

*This safety feature is valid from device modification 202/23 (see sticker on device)

13. WIRING DIAGRAM

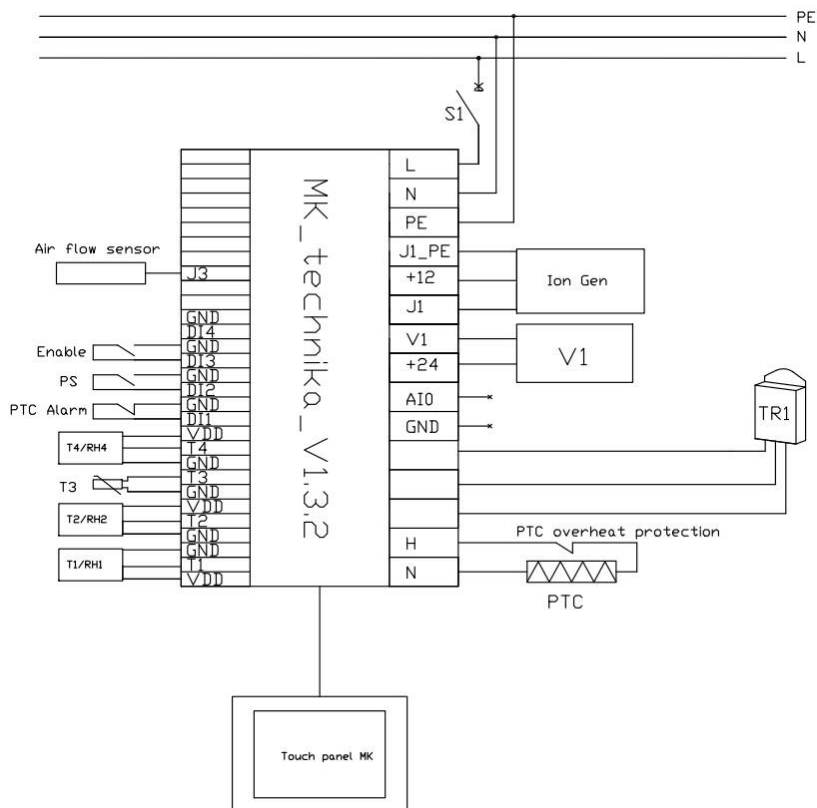

Table 6

Abbreviation	Meaning
PS – DI2/GND	Connecting an additional pressure relay. The relay indicates the available airflow in the system.
Enable – DI3/GND	Dry contact to switch the humidifier on/off. Factory setting – always short-circuited.
AI0/GND	0–10 V start-up contact from the HRV unit. The humidifier is triggered by 2.5 V.

14. DECLARATION OF CONFORMITY

This declaration confirms that the product complies with the requirements of the following Council Directives and standards:

2014/30/EU	Electromagnetic compatibility (EMC)
2014/35/EU	Low Voltage Directive (LVD)
2011/65/EU	RoHS Directive

Manufacturer: UAB MK Technika, Vilniaus g. 36K1, LT-14200, Lithuania

Product: HUMON-H200, H250

Complies with the following standards:

Safety standards LST EN ISO 12100:2011

LST EN 60204-1

LST EN 60335-1: 2021

LST EN 60335-2-98:2003

EMC standards LST EN IEC 61000-6-1:2019

LST EN 63000:2019

LST EN 55014-1: 2006/A2:2011 LST EN 55014-2: 1997/A2:2008

The product has been  marked since 2022

UAB MK Technika (2022), Vilnius region, Lithuania

Head of Technical Department



15. TECHNICAL PARAMETERS FOR THE INSTALLATION OF THE HUMIDIFIER

	Name	Parameter	Note
AIR	Minimal air volume	80 m ³ /h	In case of lower operating air volume, a pressure relay or an external dry contact has to be installed to start the humidifier
	T1/RH1 sensor	For measuring the supplied air flow	The sensor is mounted at a distance of 150 - 1000 mm from the humidifier
	T4/RH4	For measuring the extract air flow from the premises	The sensor is mounted to the extract air duct up to 2000 mm distance from the humidifier
	Outdoor air temperature sensor T3	12 ° - 15 °C	Outdoor air temperature for start/stop. When the outdoor air temperature exceeds 15°C, the humidifier stops operating. Sensor T3 can be switched off via the internal menu
WATER	Water supply tube Ø4 mm	1.5 meter length, prepared at the factory	It is forbidden to shorten or to lengthen the Ø4 mm tube. It must remain at the factory-prepared length of 1500 mm
	Water tap	With filter	A water tap with a filter must be connected in the water line before the humidifier. It protects the water gear from clogging. The filter should be cleaned on the annual basis
	Water pressure in the humidifier connection line	1.0 – 2.5 bar	In case of higher pressure, a pressure regulator should be installed and the pressure should be reduced down to the recommended value
	Reverse osmosis filter	Supply water pressure	If a reverse osmosis filter is planned to be installed before the humidifier, it is necessary to evaluate the operating principle of the planned filter (cycling, permeability, etc.) to ensure at least a minimum water pressure before the humidifier 1,0 bar. Osmosis filter cleaning cycles must not coincide with humidifier operating cycles. It is recommended to install a water tank together with the reverse osmosis filter.
DRAINAGE	Humidifier levelling with a spirit level	The humidifier must be installed well levelled	Inside the humidifier, the water collection bath has an inclination to the drainage outlet. It is necessary to ensure good water disposal from the bath
	Water drainage and trap	HL-138, HL-136	The water disposal system shall be equipped with a trap, which forms a barrier for the sewer odours to enter the air supply duct
	Sewage system	Sewage drainage	The system must be open-type, depressurized and sufficiently lowered to allow the water to flow out of the drain tray. It is not recommended to connect to other or together with other devices' sewage systems, which may include circulation pumps or other obstacles to free drainage.
ELECTRICITY	The cable positioning	100 mm	Signal cables shall be installed at a distance of at least 100 mm from the 220 V power cables
RECOMMENDED SETTINGS	The temperature of the inlet air before the humidifier	19° – 23°C	The humidifier does not operate, if the air temperature after the ventilation unit (before the humidifier) is below 14°C. The adiabatic process tends to fail at low temperatures. Important: the humidifier does not heat the air more than the temperature in the inlet of the humidifier (even if a higher temperature in the outlet of humidifier is set in the main window).
	Supplied temperature T1	18°-19°C	Recommended parameter to set
	Supplied humidity RH1	50% - 65%	Recommended parameter to set
	Humidifier operation		From the left: demand for humidification / there is an air flow / demand for heating. The demand for humidification and heating varies according to the conditions and the situation of the process. The air flow icon shall always be active.

Table 7. Absolute humidity in grams per one kilo of air (g/kg)

		Temperature, °C											
		14°C	15°C	16°C	17°C	18°C	19°C	20°C	21°C	22°C	23°C	24°C	25°C
Relative humidity, %	RH29%	2,9	3,1	3,3	3,5	3,8	4,0	4,3	4,6	4,9	5,2	5,5	5,8
	RH31%	3,1	3,3	3,4	3,8	4,0	4,3	4,6	4,9	5,2	5,5	5,9	6,3
	RH33%	3,3	3,5	3,8	4,0	4,3	4,6	4,9	5,2	5,5	5,9	6,3	6,7
	RH35%	3,5	3,7	4,0	4,3	4,5	4,8	5,2	5,5	5,9	6,2	6,6	7,1
	RH37%	3,7	4,0	4,2	4,5	4,8	5,1	5,5	5,8	6,2	6,6	7,0	7,5
	RH39%	3,9	4,2	4,5	4,7	5,1	5,4	5,8	6,1	6,5	6,9	7,4	7,9
	RH41%	4,1	4,4	4,7	5,0	4,1	5,7	6,0	6,4	6,9	7,3	7,8	8,3
	RH43%	4,3	4,6	4,9	5,2	5,6	6,0	6,3	6,8	7,2	7,7	8,2	8,7
	RH45%	4,5	4,8	5,1	5,5	5,8	6,2	6,6	7,1	7,5	8,0	8,5	9,1
	RH47%	4,7	5,0	5,4	5,7	6,1	6,5	6,9	7,4	7,9	8,4	8,9	9,5
	RH49%	4,9	5,2	5,6	6,0	6,4	6,8	7,2	7,7	8,2	8,7	9,3	9,9
	RH51%	5,1	5,5	5,8	6,2	6,6	7,1	7,5	8,0	8,5	9,1	9,7	10,5
	RH53%	5,3	5,7	6,0	6,5	6,9	7,3	7,8	8,3	8,9	9,4	10,0	10,7
	RH55%	5,5	5,9	6,3	6,7	7,1	7,6	8,1	8,6	9,2	9,8	10,4	11,1
	RH57%	5,7	6,1	6,5	6,9	7,4	7,9	8,4	9,0	9,5	10,2	10,8	11,5
	RH59%	5,9	6,3	6,7	7,2	7,7	8,2	8,7	9,3	9,9	10,5	11,2	11,9
	RH61%	6,1	6,5	7,0	7,4	7,9	8,4	9,0	9,6	10,2	10,9	11,6	12,3
RH63%	6,3	6,7	7,2	7,7	8,2	8,7	9,3	9,9	10,5	11,2	11,9	12,7	
RH65%	6,5	6,9	7,4	7,9	8,4	9,0	9,6	10,2	10,9	11,6	12,3	13,1	





www.mktechnika.lt

HUMON-EN-2024-09