

ETA K 1700 F WOJR

163730

- Flat air handling unit with counter flow heat exchanger
- Ceiling mounting, version right
- Frameless, double wall housing made of galvanized steel sheet, insulated
- Constant air flow EC fans, integrated controls
- Automatic summer bypass
- Warm water heating, without cooling, panel filter F7/M5
- Constructed acc. to VDI 6022

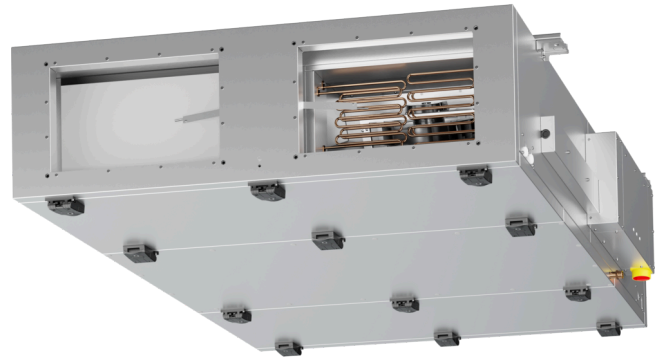

to the product detail page

ETA K 1700 F WOJR

163730

MAP

Name	Value	Unit
Volume flow	0	m³/h
Pressure	0	Pa

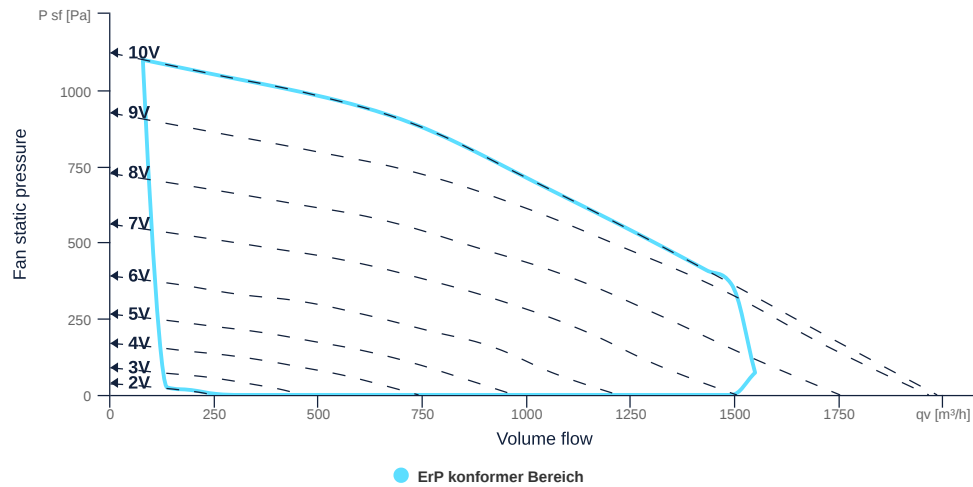

EXTRACT AIR MAP

Name	Value	Unit
Volume flow	0	m³/h
Pressure	0	Pa

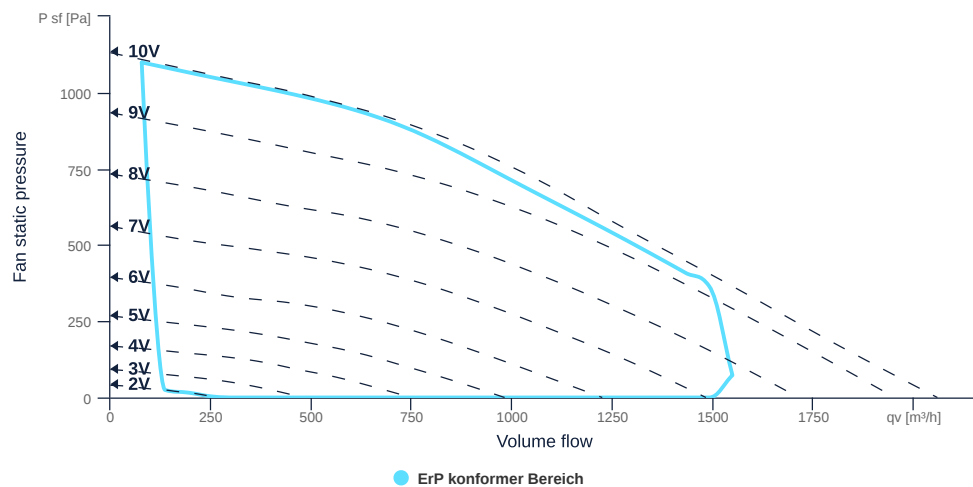

to the product detail page

GENERAL DATA

Name	Value	Unit	Formula symbol
Labeling	CE, UKCA		
Duct size	500x300		WxH _{duct}
Rated voltage (entire device)	230	V	U _{rated}
Phases (entire device)	1~		phase
Electrical protection (entire device)	6 A		fuse
Housing material	Galvanized steel		mat _{casing}
IP-protection class (casing)	IP41		IP _{casing}
Weight	250	kg	m
Nominal air flow rate, nominal point m ³ /h	990	m ³ /h	q _{v,nom}
Nominal external pressure, static	710.3	Pa	p _{s,nom}
Connection side supply air	Right		L/R
Type of the ventilation-unit	BVU - supply air		AHU _{type}
Type of heat-recovery-system	recuperative		HRS _{type}
Type of the heater	Hot water		H _{type}
Type of cooler	No		C _{type}
Outdoor installation	No		outdoor
Speed control	variable speed control		VSD _{type}
Filter class extract air	ISO ePM10 50%		F _{class, eta}
Filter class supply air	ISO ePM1 55%		F _{class, sup}

ERP DATA (LOT 6)

Name	Value	Unit	Formula symbol
Energy performance supply air filter		E	
Energy performance extract air filter		E	
Thermal efficiency HRS, Nominal-point	82.1	%	t _{NRVU}
Nominal air flow rate, nominal point m ³ /s	0.28	m ³ /s	q _{v,nom}
Actual electrical input power, nominal point	1.04	kW	P _{e,nom}
Internal specific fan power, nominal point	1033	Ws/m ³	SFP _{int}
Face velocity, nominal point	1.1	m/s	v _{nom}
Nominal external pressure, static	710.3	Pa	p _{s,nom}
supply air fan static efficiency, nominal point	63.9	%	η _{es,SUP}
static efficiency of the extract fan, nominal point	63.9	%	η _{es,EHA}
Highest external air leakage rate	1.55	%	
Enclosure sound level, nominal point	63	dB(A)	LWA2
Rating	Product is compliant 2018		



to the product detail page

ETA K 1700 F WOJR

163730

ruck

MAXIMAL DATA

Name	Value	Unit	Formula symbol
Max. power consumption (device)	1200	W	$P_{ed, max}$
Max. operating current (device)	5	A	$I_{ed, max}$
Max. speed	3410	1/min	n_{max}
Max. stat. efficiency	35.8	%	η_{es}
Max. fan efficiency	35.9	%	η_e
Max. flowrate	1985	m ³ /h	q_v, max
Max. stat pressure	1120	Pa	$p_{sf, max}$
Max. medium temperature	40	°C	T_m, max
Max. environment temperature	40	°C	$T_{amb, max}$
Min. environment temperature	-20	°C	$T_{amb, min}$

FILTER DATA

Name	Value	Unit	Formula symbol
Degree of separation (supply air)	55	%	
Degree of separation (extract air)	50	%	
Filter group (extract air)	ISO ePM10		
Filter group (supply air)	ISO ePM1		

to the product detail page



CIRCUIT DIAGRAMS / DIMENSIONAL DRAWINGS

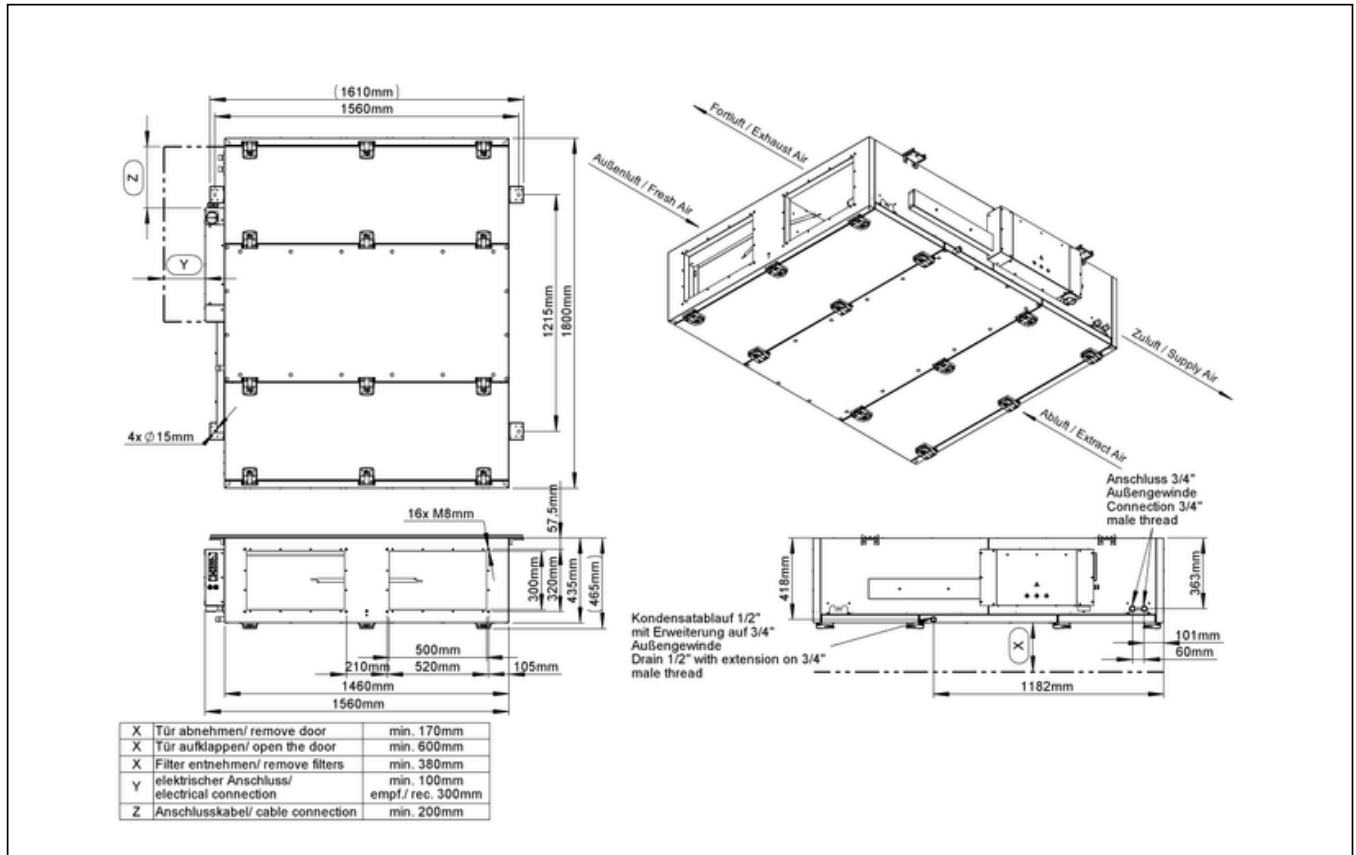

ETA K 1700 F WOJR

163730

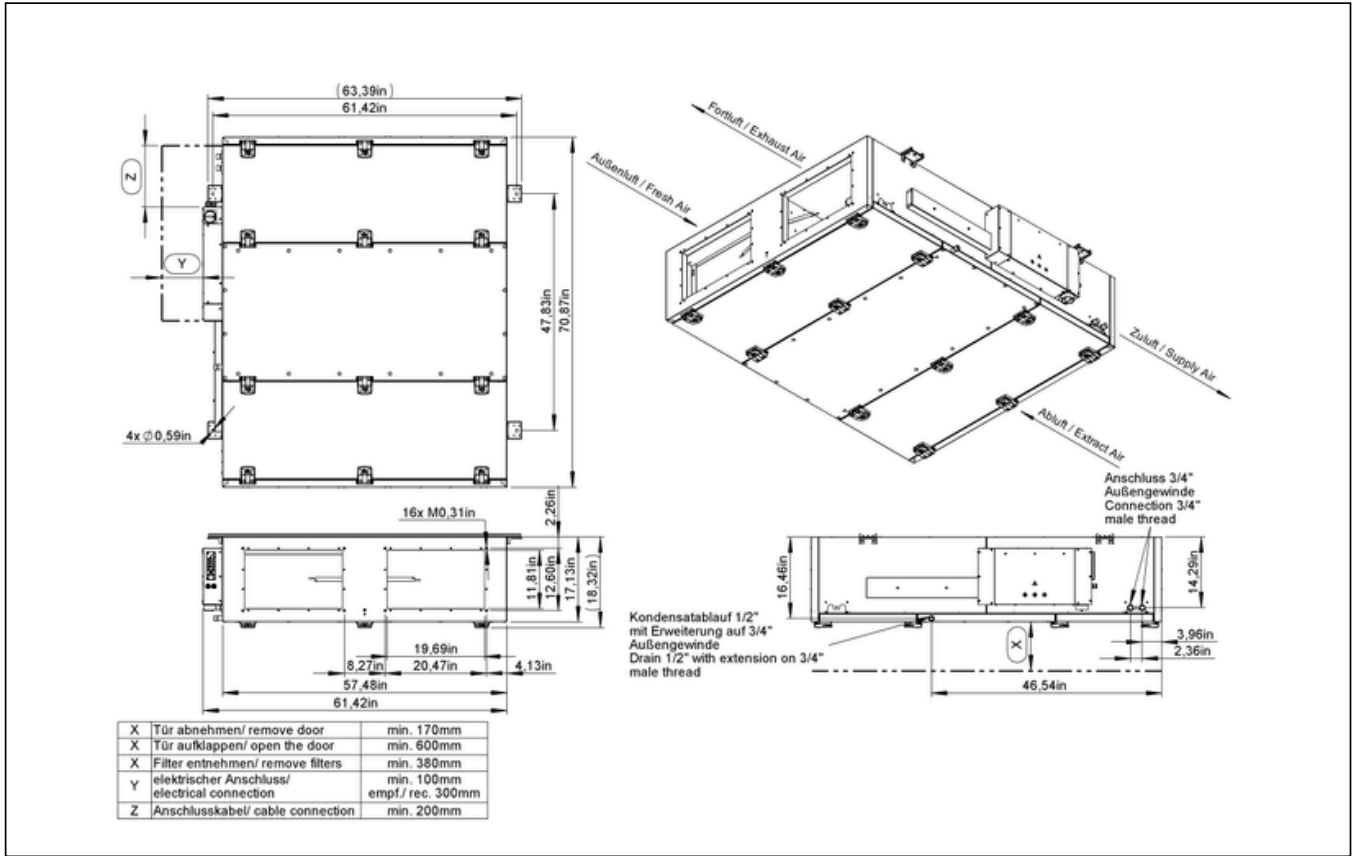

ETA K 1700 F WOJR

163730

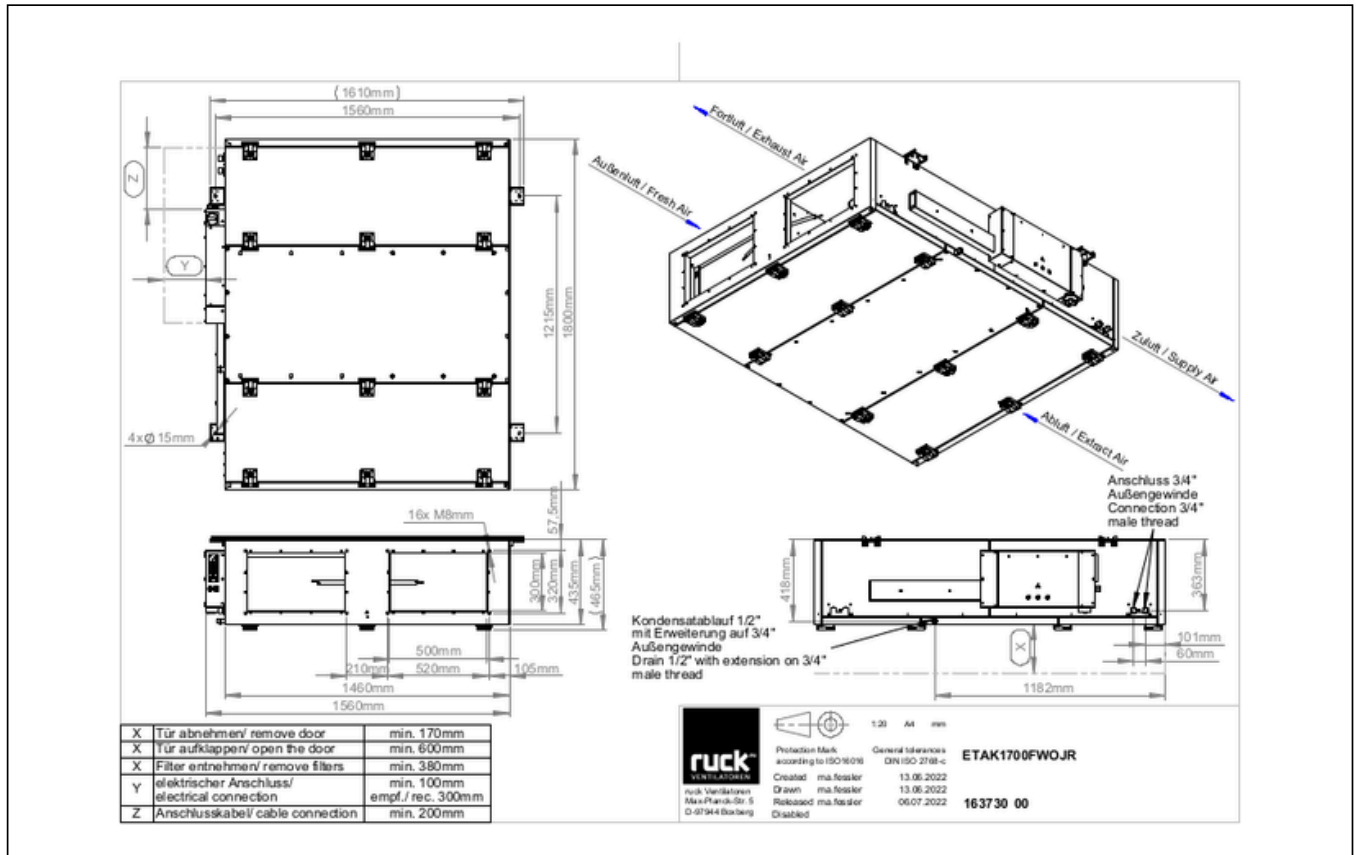

to the product detail page

ETA K 1700 F WOJR

163730

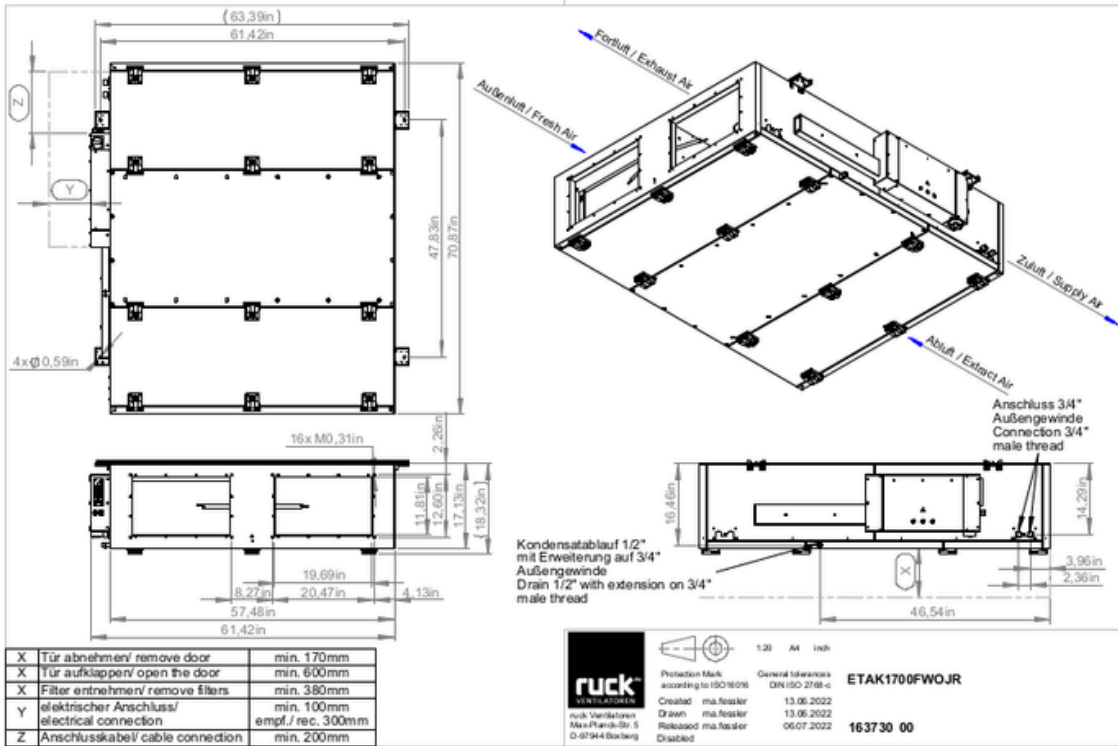

to the product detail page