

# ETA K 1300 F WOJR

163799

---

- Flat air handling unit with counter flow heat exchanger
- Ceiling mounting, version right
- Frameless, double wall housing made of galvanized steel sheet, insulated
- Constant air flow EC fans, integrated controls
- Automatic summer bypass
- Warm water heating, without cooling, panel filter F7/M5
- Constructed acc. to VDI 6022

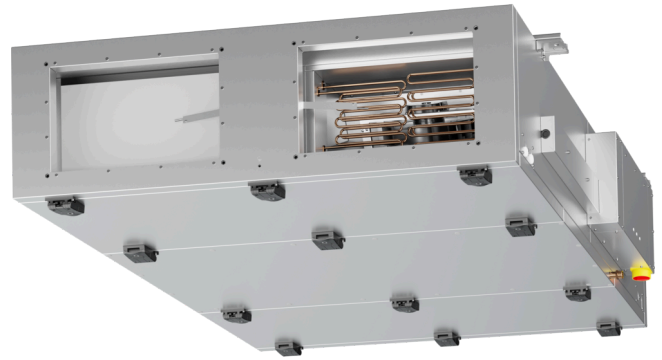

# ETA K 1300 F WOJR

163799

## MAP

Name	Value	Unit
Volume flow	0	m³/h
Pressure	0	Pa

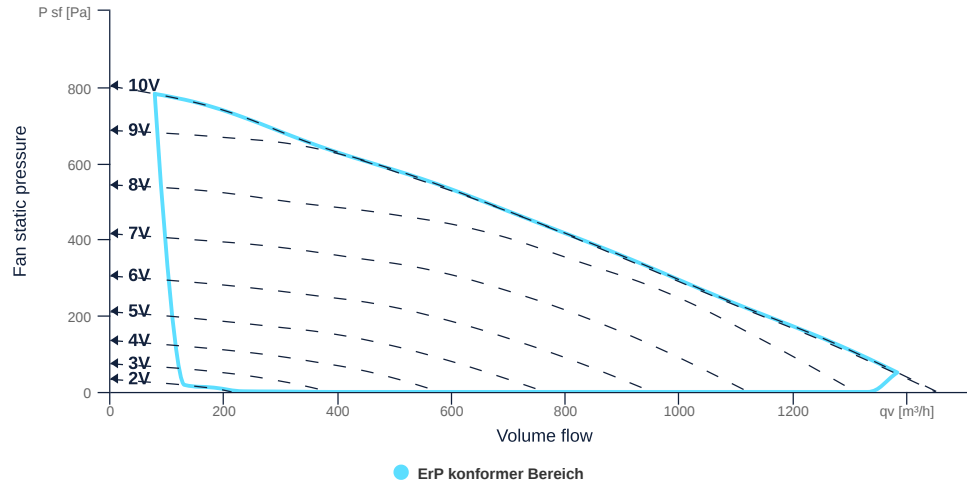

## EXTRACT AIR MAP

Name	Value	Unit
Volume flow	0	m³/h
Pressure	0	Pa

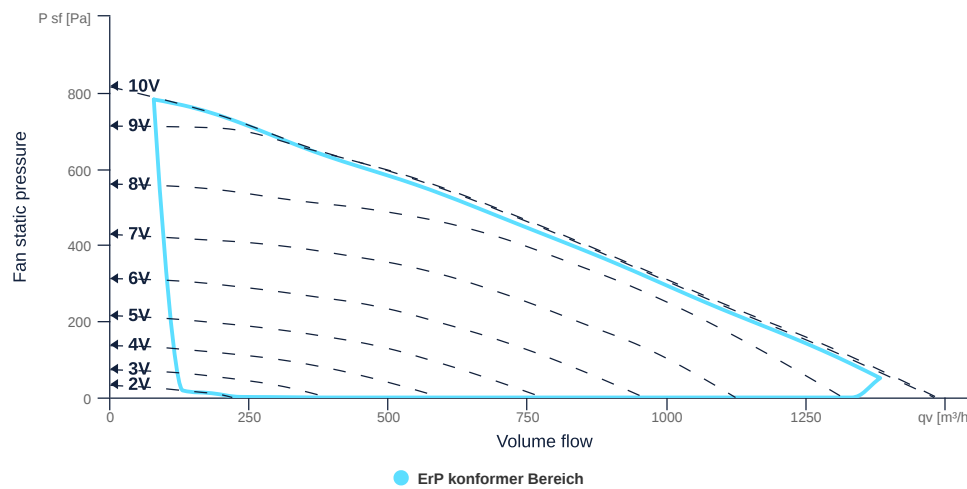

to the product detail page

## GENERAL DATA

Name	Value	Unit	Formula symbol
Labeling	CE, UKCA		
Duct size	500x300		WxH <sub>duct</sub>
Rated voltage (entire device)	230	V	U <sub>rated</sub>
Phases (entire device)	1~		phase
Electrical protection (entire device)	6 A		fuse
Housing material	Galvanized steel		mat <sub>casing</sub>
IP-protection class (casing)	IP41		IP <sub>casing</sub>
Weight	247	kg	m
Nominal air flow rate, nominal point m <sup>3</sup> /h	673.2	m <sup>3</sup> /h	q <sub>v,nom</sub>
Nominal external pressure, static	368.7	Pa	p <sub>s,nom</sub>
Connection side supply air	Right		L/R
Type of the ventilation-unit	BVU - supply air		AHU <sub>type</sub>
Type of heat-recovery-system	recuperative		HRS <sub>type</sub>
Type of the heater	Hot water		H <sub>type</sub>
Type of cooler	No		C <sub>type</sub>
Outdoor installation	No		outdoor
Speed control	variable speed control		VSD <sub>type</sub>
Filter class extract air	ISO ePM10 50%		F <sub>class, eta</sub>
Filter class supply air	ISO ePM1 55%		F <sub>class, sup</sub>

## ERP DATA (LOT 6)

Name	Value	Unit	Formula symbol
Energy performance supply air filter		E	
Energy performance extract air filter		E	
Thermal efficiency HRS, Nominal-point	84	%	t <sub>NRVU</sub>
Nominal air flow rate, nominal point m <sup>3</sup> /s	0.19	m <sup>3</sup> /s	q <sub>v,nom</sub>
Actual electrical input power, nominal point	0.42	kW	P <sub>e,nom</sub>
Internal specific fan power, nominal point	653.4	Ws/m <sup>3</sup>	SFP <sub>int</sub>
Face velocity, nominal point	0.7	m/s	V <sub>nom</sub>
Nominal external pressure, static	368.7	Pa	p <sub>s,nom</sub>
supply air fan static efficiency, nominal point	54.9	%	η <sub>es,SUP</sub>
static efficiency of the extract fan, nominal point	54.9	%	η <sub>es,EHA</sub>
Highest external air leakage rate	2.27	%	
Enclosure sound level, nominal point	59	dB(A)	LWA2
Rating	Product is compliant 2018		



to the product detail page

## MAXIMAL DATA

Name	Value	Unit	Formula symbol
Max. power consumption (device)	700	W	$P_{ed, max}$
Max. operating current (device)	2.56	A	$I_{ed, max}$
Max. speed	2950	1/min	$n_{max}$
Max. stat. efficiency	31.3	%	$\eta_{es}$
Max. fan efficiency	31.4	%	$\eta_e$
Max. flowrate	1450	m <sup>3</sup> /h	$q_{v, max}$
Max. stat pressure	800	Pa	$p_{sf, max}$
Max. medium temperature	40	°C	$T_{m, max}$
Max. environment temperature	40	°C	$T_{amb, max}$
Min. environment temperature	-20	°C	$T_{amb, min}$

## FILTER DATA

Name	Value	Unit	Formula symbol
Degree of separation (supply air)	55	%	
Degree of separation (extract air)	50	%	
Filter group (extract air)	ISO ePM10		
Filter group (supply air)	ISO ePM1		



to the product detail page

## CIRCUIT DIAGRAMS / DIMENSIONAL DRAWINGS

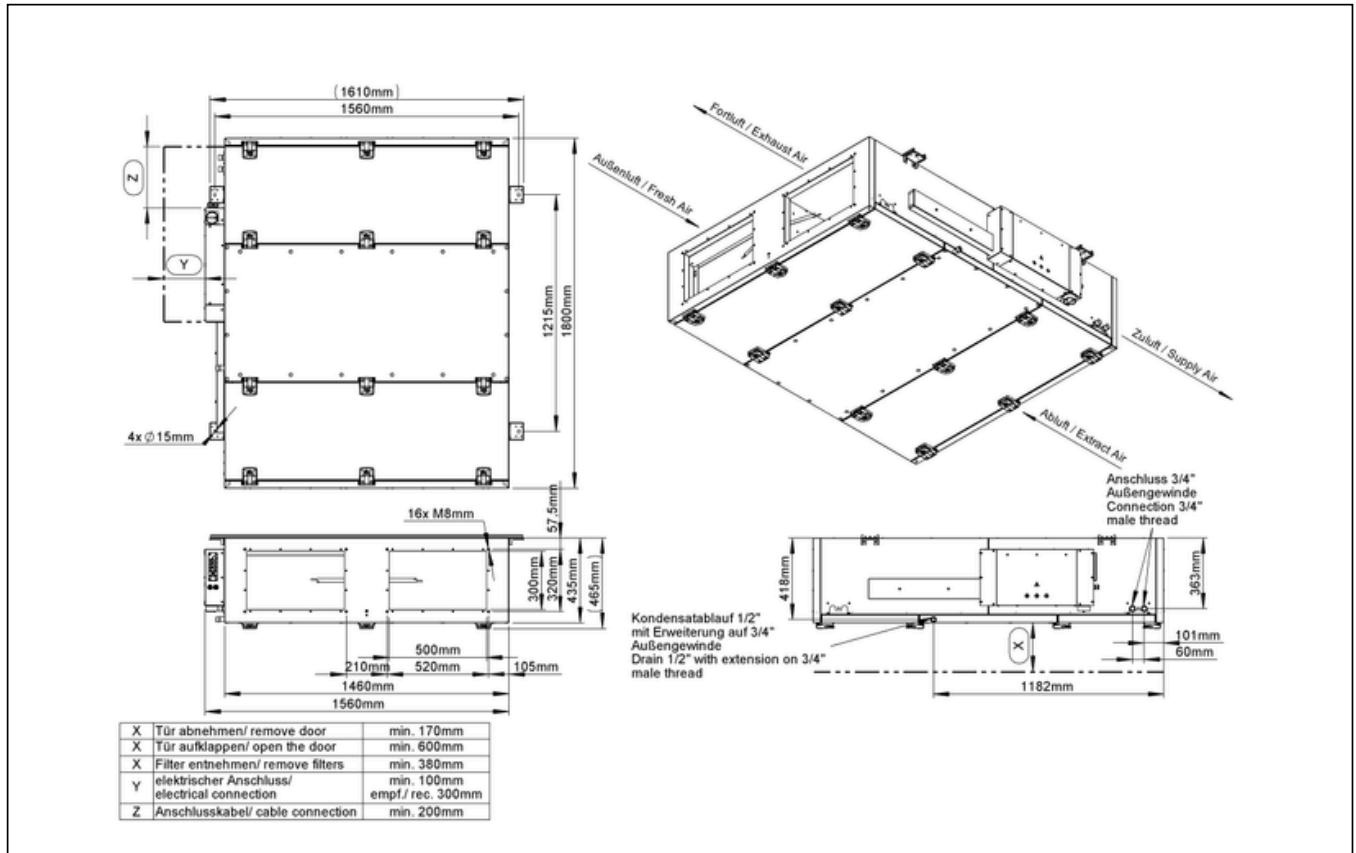

# ETA K 1300 F WOJR

163799

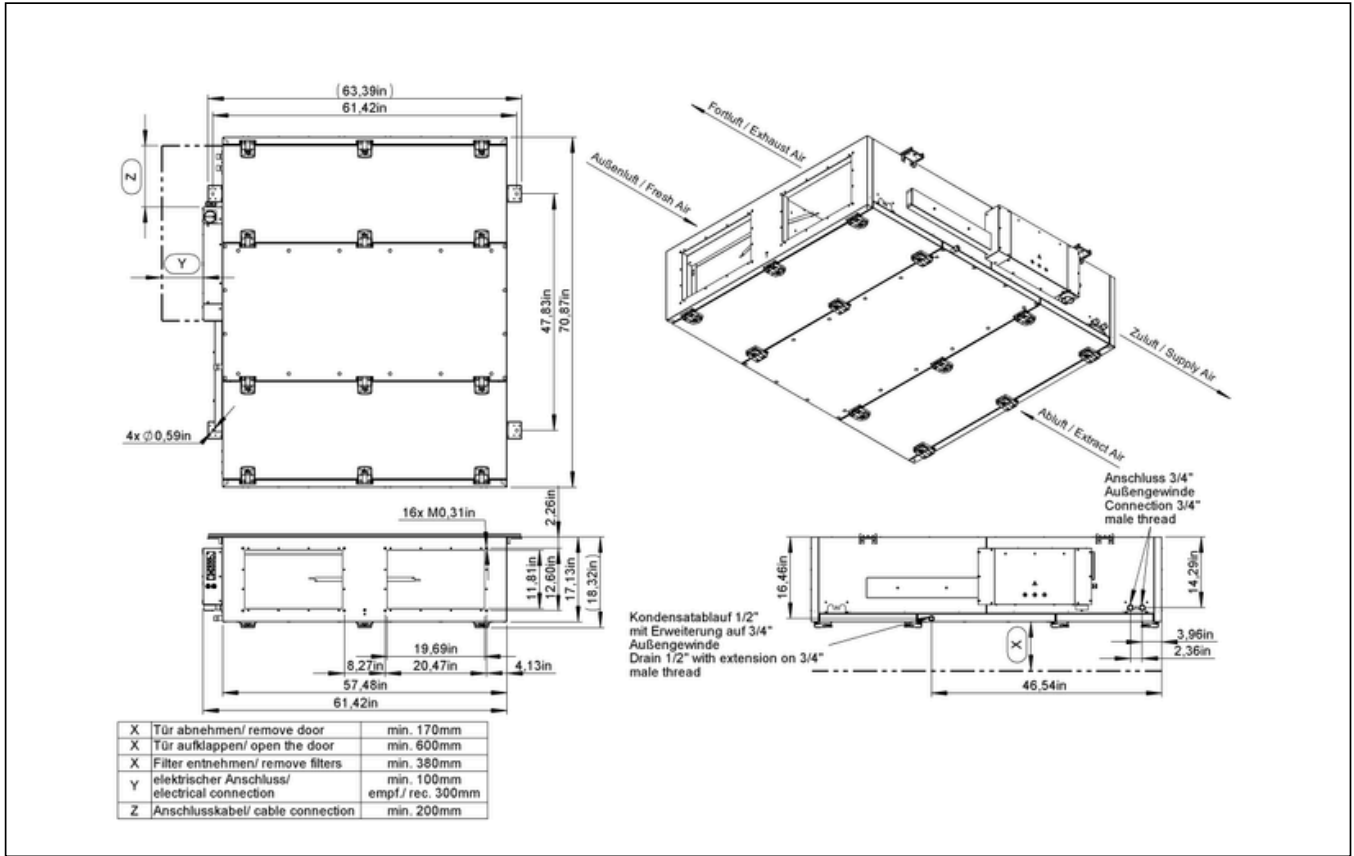

# ETA K 1300 F WOJR

163799

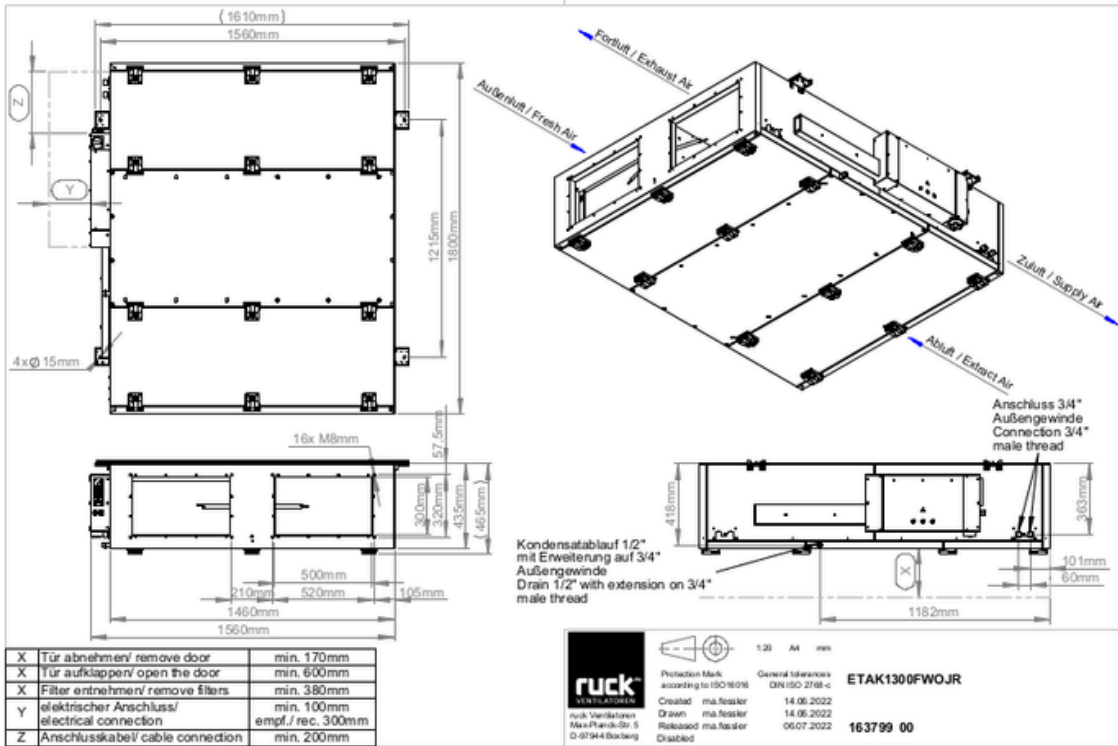

to the product detail page

# ETA K 1300 F WOJR

163799

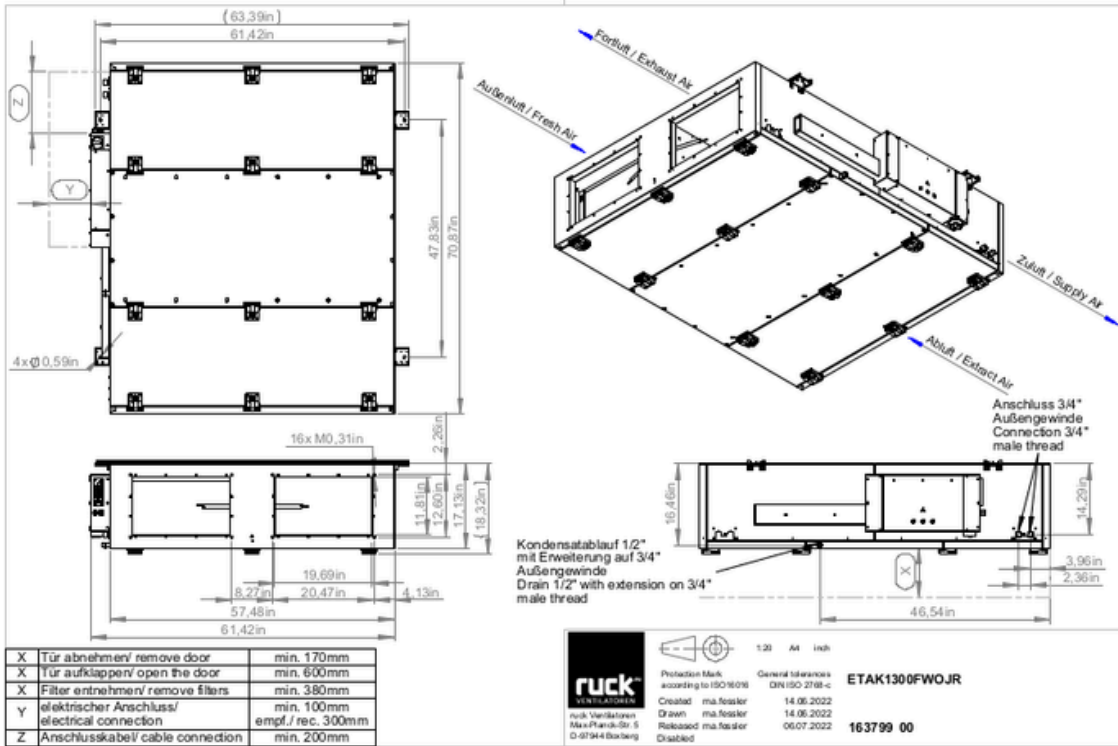

to the product detail page