

# ETA K 2000 H ODJR

165425

---

- Compact air handling unit with counter flow heat exchanger
- Horizontal connections, version right
- Frameless, double wall housing made of galvanized steel sheet, insulated
- Without heating, DX cooling, panel filter F7/M5
- For indoor and outdoor installation (optional accessories)
- Constructed acc. to VDI 6022
- Attention: Please note the calculated cooling/heating capacity and the displayed volume of the DX coils



to the product detail page

# ETA K 2000 H ODJR

165425

## MAP

Name	Value	Unit
Volume flow	0	m³/h
Pressure	0	Pa

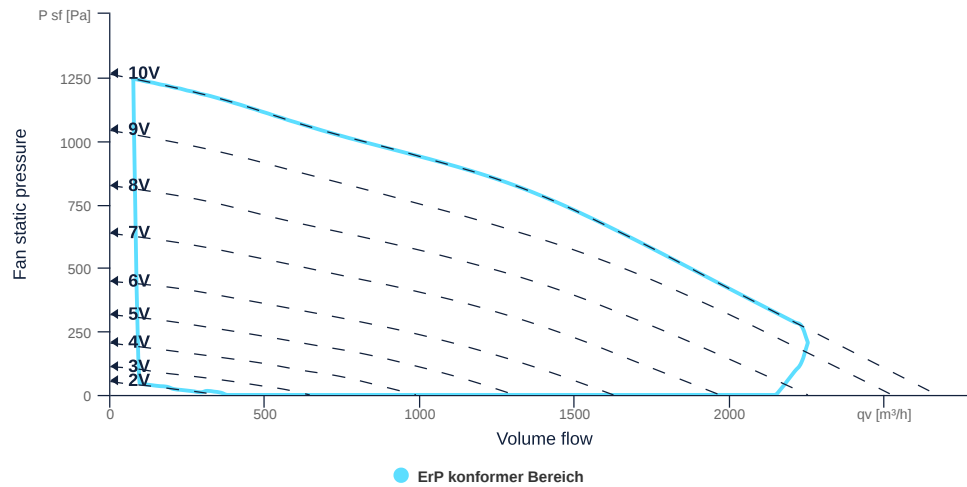

## EXTRACT AIR MAP

Name	Value	Unit
Volume flow	0	m³/h
Pressure	0	Pa

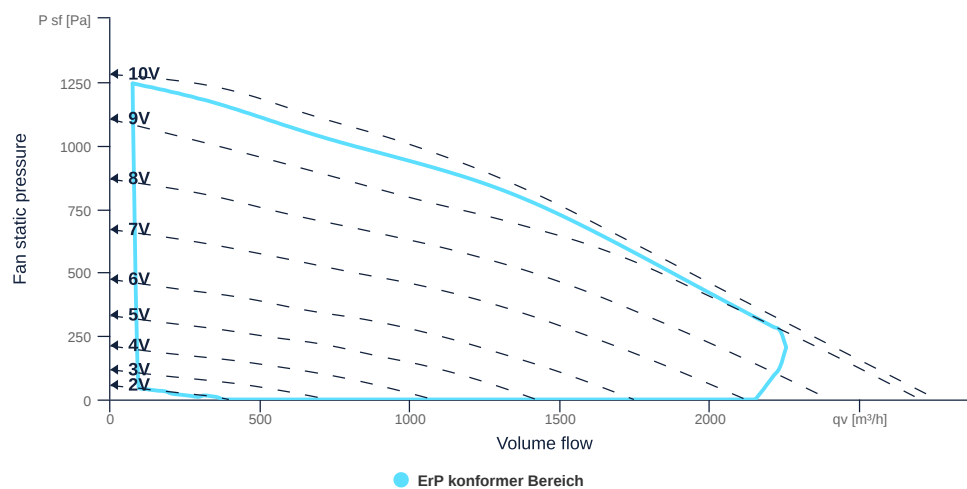

to the product detail page

# ETA K 2000 H ODJR

165425

ruck

## GENERAL DATA

Name	Value	Unit	Formula symbol
Labeling	CE, UKCA		
Duct size	600x350		WxDuct
Rated voltage (entire device)	230	V	U <sub>rated</sub>
Phases (entire device)	1~		phase
Electrical protection (entire device)	10 A		fuse
Housing material	Galvanized steel		mat <sub>casing</sub>
IP-protection class (casing)	IP41		IP <sub>casing</sub>
IP-protection class (entire device)	IP41		IP <sub>compl</sub>
IP-Protection class (terminal box)	IP44		IP <sub>ebox</sub>
Weight	282	kg	m
Nominal air flow rate, nominal point m <sup>3</sup> /h	1461.6	m <sup>3</sup> /h	q <sub>v,nom</sub>
Nominal external pressure, static	735.7	Pa	p <sub>s,nom</sub>
Connection side supply air	Right		L/R
Type of the ventilation-unit	BVU - supply air		AHU <sub>type</sub>
Type of heat-recovery-system	recuperative		HRS <sub>type</sub>
Type of the heater	Condenser		H <sub>type</sub>
Type of cooler	Evaporator		C <sub>type</sub>
Outdoor installation	Yes, up to -20°C		outdoor
Leak class	L2		L <sub>class</sub>
Speed control	variable speed control		VSD <sub>type</sub>
Filter class extract air	ISO ePM10 50%		F <sub>class, eta</sub>
Filter class supply air	ISO ePM1 55%		F <sub>class, sup</sub>
Mechanical stability class	D2		D <sub>class</sub>

## ERP DATA (LOT 6)

Name	Value	Unit	Formula symbol
Energy performance supply air filter	E		
Energy performance extract air filter	E		
Thermal efficiency HRS, Nominal-point	85	%	tNRVU
Nominal air flow rate, nominal point m <sup>3</sup> /s	0.41	m <sup>3</sup> /s	q <sub>v,nom</sub>
Actual electrical input power, nominal point	1.45	kW	P <sub>e,nom</sub>
Internal specific fan power, nominal point	1126.5	Ws/m <sup>3</sup>	SFP <sub>int</sub>
Face velocity, nominal point	1.3	m/s	V <sub>nom</sub>
Nominal external pressure, static	735.7	Pa	p <sub>s,nom</sub>
supply air fan static efficiency, nominal point	64.8	%	η <sub>es,SUP</sub>
static efficiency of the extract fan, nominal point	64.8	%	η <sub>es,EHA</sub>
Highest external air leakage rate	0.61	%	
Enclosure sound level, nominal point	71	dB(A)	LWA2
Rating	Product is compliant 2018		



to the product detail page

# ETA K 2000 H ODJR

165425

## MAXIMAL DATA

Name	Value	Unit	Formula symbol
Max. power consumption (device)	1550	W	$P_{ed, max}$
Max. operating current (device)	6.8	A	$I_{ed, max}$
Max. speed	3380	1/min	$n_{max}$
Max. stat. efficiency	40.5	%	$\eta_{es}$
Max. fan efficiency	40.6	%	$\eta_e$
Max. flowrate	2670	m <sup>3</sup> /h	$q_{v, max}$
Max. stat pressure	1260	Pa	$p_{sf, max}$
Max. medium temperature	40	°C	$T_{m, max}$
Max. environment temperature	40	°C	$T_{amb, max}$
Min. environment temperature	-25	°C	$T_{amb, min}$

## FILTER DATA

Name	Value	Unit	Formula symbol
Degree of separation (supply air)	55	%	
Degree of separation (extract air)	50	%	
Filter group (extract air)	ISO ePM10		
Filter group (supply air)	ISO ePM1		



to the product detail page

# ETA K 2000 H ODJR

165425

## CIRCUIT DIAGRAMS / DIMENSIONAL DRAWINGS

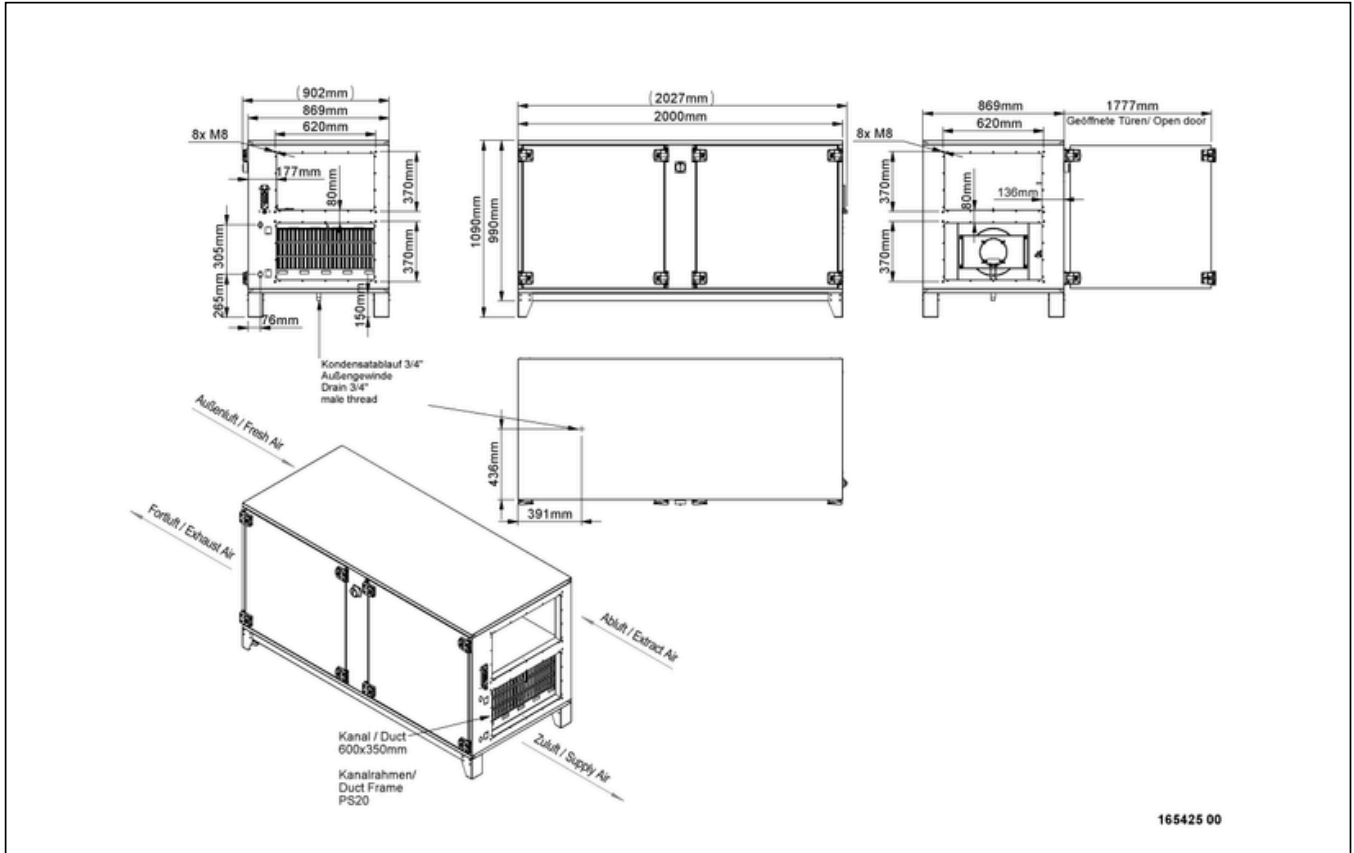

# ETA K 2000 H ODJR

165425

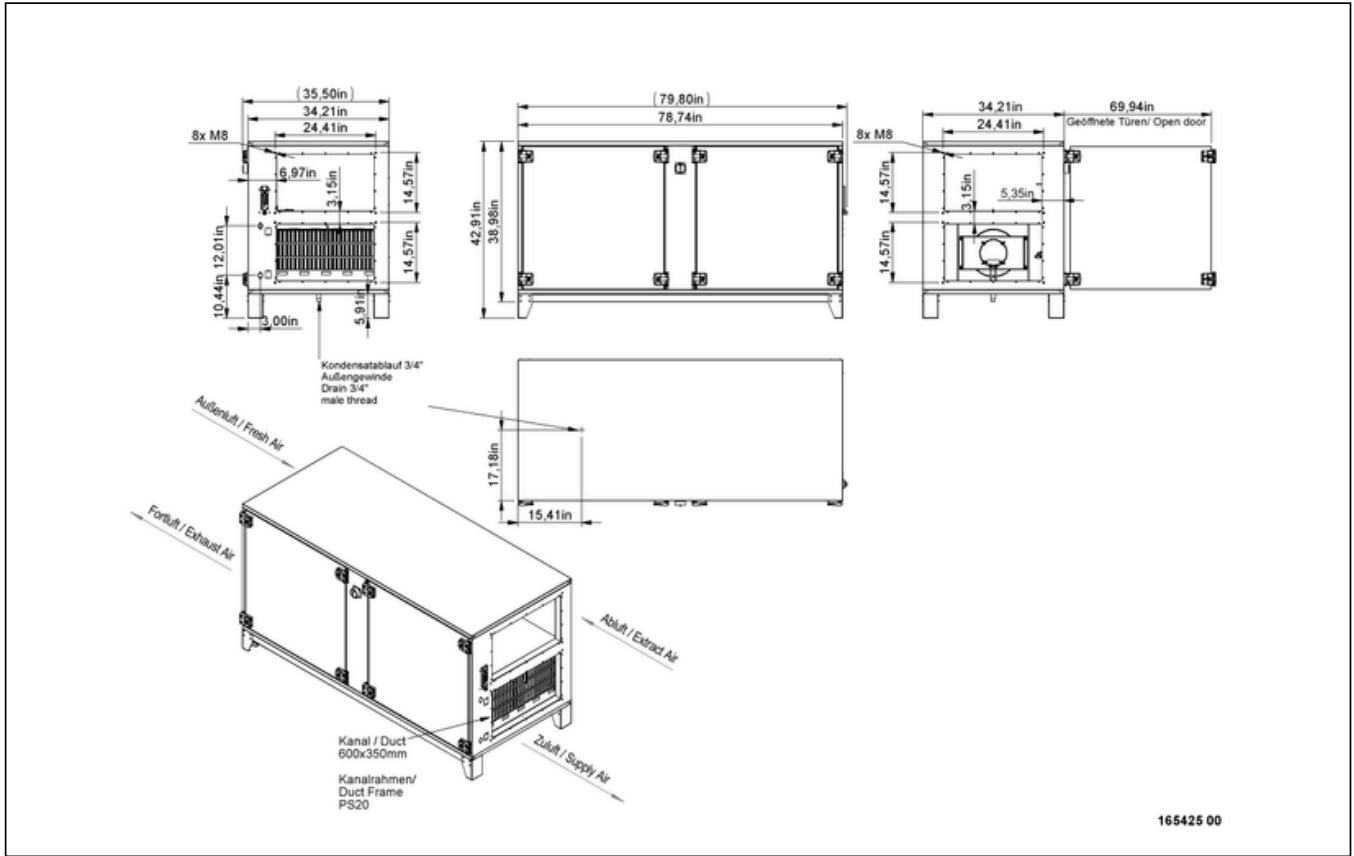

to the product detail page

# ETA K 2000 H ODJR

165425

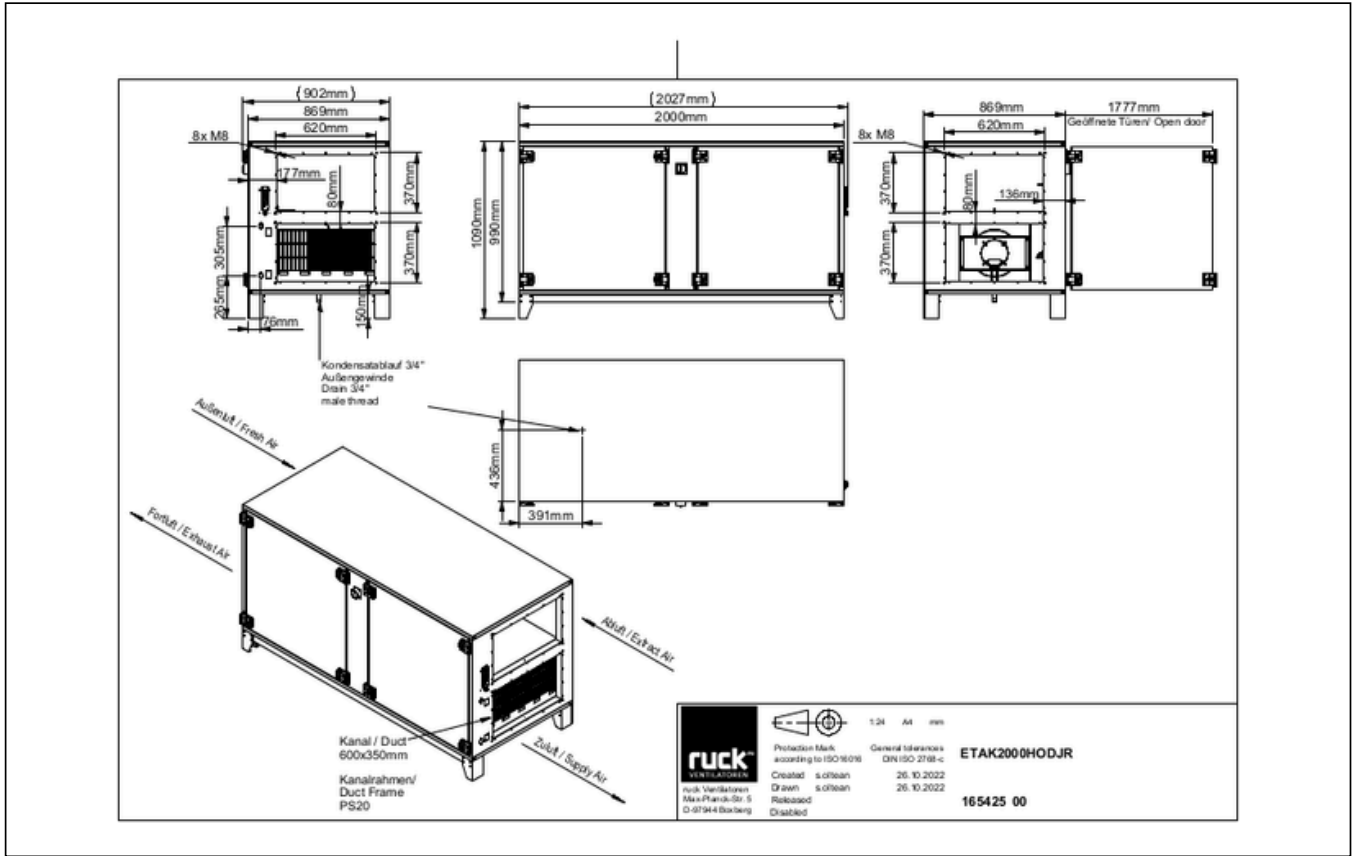

# ETA K 2000 H ODJR

165425

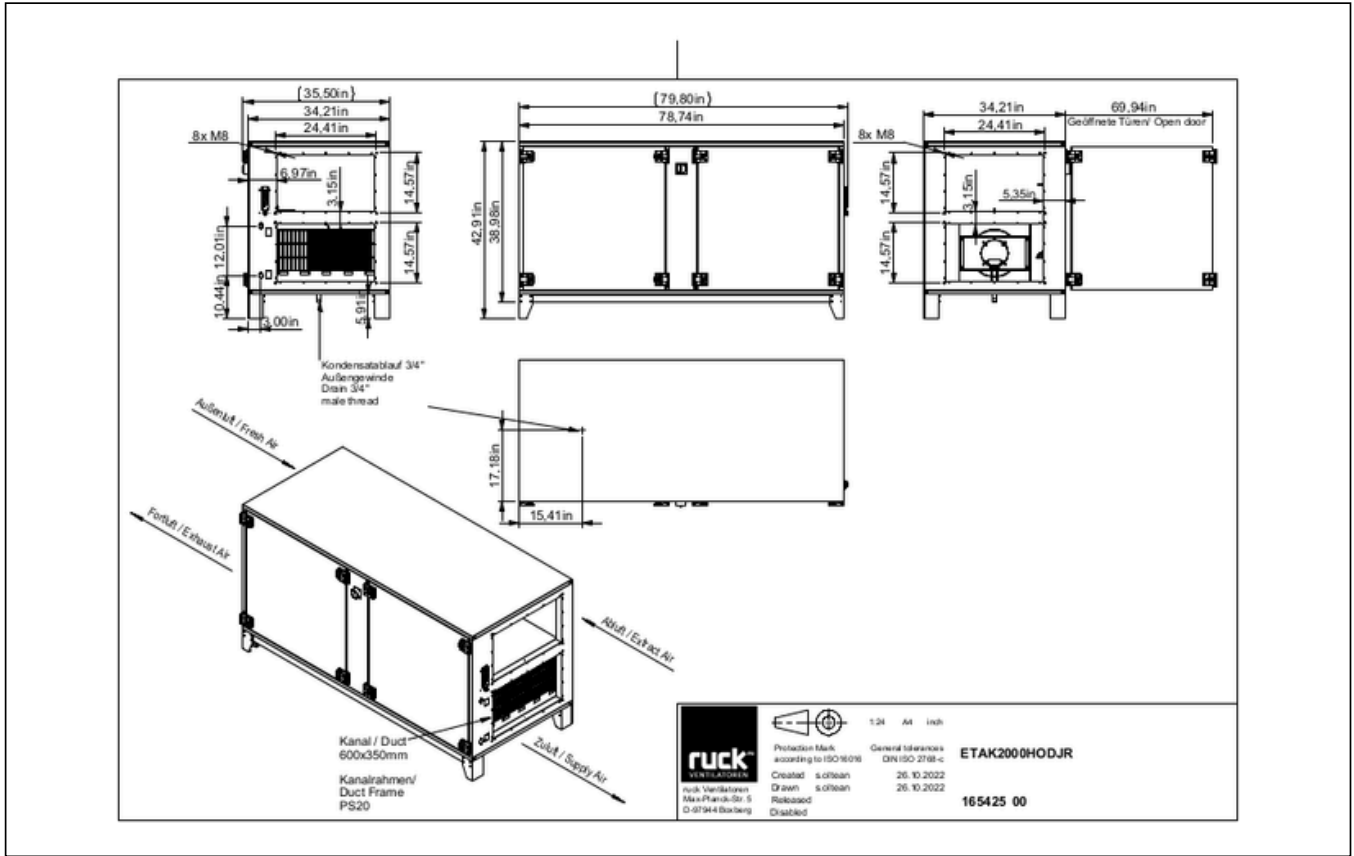

to the product detail page



# ETA K 2000 H ODJR

165425

## MECHANICAL ACCESSORIES

**RSK 355D | 113491**



- Back draught shutter for tube fitting
- Galvanized steel sheet housing
- Aluminum flaps
- Integrated gasket

**VS 6035 | 102808**



- Duct connector, flexible
- Standard profile flange P20
- Galvanized steel sheet, plastic band (PVC)
- Temperature resistant up to 70 °C

**VM 355 | 102653**



- Fast clamps for sound decoupling and sealing
- Galvanized steel sheet, 5 mm Neopren gasket
- 1 Pack = 2 pieces

**KWRI 6030 01 | 125509**



- Cold water cooling coil, galvanized steel sheet, insulated
- Integrated condensate tray, drip separator
- With NTC temperature sensor
- Air direction and connection side interchangeable (Data sheet)

**DVRI 6030 01 | 125510**



- Direct evaporator, galvanized steel sheet, insulated
- Integrated condensate tray, drip separator
- With NTC temperature sensor
- Air direction and connection side interchangeable (Data sheet)

**MAK 315 02 | 125467**



- Motor shut-off flap
- With actuator 3-point-control, with actuator 230 V, 50 Hz

**MAK 355 02 | 125476**



- Motor shut-off flap
- With actuator 3-point-control, with actuator 230 V, 50 Hz

**SYS 01 | 123971**



- Ball siphon
- Type suction side

**KWRI 9030 01 | 125549**



- Cold water cooling coil, galvanized steel sheet, insulated
- Integrated condensate tray, drip separator
- With NTC temperature sensor
- Air direction and connection side interchangeable (Data sheet)

**DVRI 9030 01 | 125552**



- Direct evaporator, galvanized steel sheet, insulated
- Integrated condensate tray, drip separator
- With NTC temperature sensor
- Air direction and connection side interchangeable (Data sheet)

**MAK 315 01 | 125466**



- Motor shut-off flap
- With spring return VDI 6022, with actuator 230 V, 50 Hz

**MAK 355 01 | 125475**



- Motor shut-off flap
- With spring return VDI 6022, with actuator 230 V, 50 Hz

**RSK 315D | 113489**



- Back draught shutter for tube fitting
- Galvanized steel sheet housing
- Aluminum flaps
- Integrated gasket

**VM 315 | 102652**



- Fast clamps for sound decoupling and sealing
- Galvanized steel sheet, 5 mm Neopren gasket
- 1 Pack = 2 pieces

**MAK H E 03 3P | 164971**



- Motorized shut-off flap
- Made of galvanized sheet steel, insulated
- Open-close, with 3-point control
- Actuator 230 V, 50/60 Hz

**MAK H E 03 FR | 164972**



- Motorized shut-off flap
- Made of galvanized sheet steel, insulated
- Open-close, with spring return
- Actuator 230 V, 50/60 Hz, 4 Nm



to the product detail page

# ETA K 2000 H ODJR

165425

**WSH ETA K 2000 H | 164525**

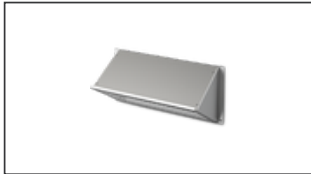

- Weather protection hood
- Galvanized steel sheet

**RD ETA K 2000 H | 165474**



- Rain cover for outdoor installation
- Galvanized steel sheet

**UKR 6035 02 | 164940**



- Transition duct / tube
- Steel sheet, galvanized
- 600 x 350 mm / NW 315 mm with seal lips

**UKR 6035 03 | 164941**



- Transition duct / tube
- Steel sheet, galvanized
- 600 x 350 mm / NW 355 mm with seal lips

**LFP 73 ISO ePM10 50% | 168785**



- Air filter panel
- ISO ePM10 50%
- 760x400x96 mm

**LFP 73 ISO ePM1 55% | 168788**

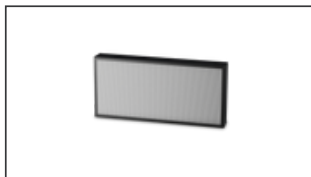

- Air filter panel
- ISO ePM1 55%
- 760x400x96 mm

**SDS 315 | 169609**



- Rigid tube silencer
- Galvanized steel sheet
- Sound insulation packing 50 mm (mineral wool)

**SDS 355 | 169611**



- Rigid tube silencer
- Galvanized steel sheet
- Sound insulation packing 50 mm (mineral wool)



# ETA K 2000 H ODJR

165425

## ELECTRICAL ACCESSORIES

**SEN RAUCH 02 | 148637**



- Duct smoke sensor
- Contamination display in % and message at 70 %
- 1 Switching contact, 8 A, 250 V AC 1 nc, 8 A, 250 V AC
- Supply flow 1 - 20 m/s

**SEN TEMP | 148639**



- Duct temperature sensor
- Measuring range -50..+150 °C
- NTC 5k
- Incl. mounting clip, mounting screws

**SEN P1000 | 126080**



- Differential pressure sensor
- P-control, PV-control
- P = 2 pcs. required, PV = 1 pcs. required

**SEN RAUCH 01 | 148638**



- Duct smoke sensor
- Contamination display in % and message at 70 %

**SEN CO2 03 | 168178**



- CO2 sensor for demand based volume flow control
- Supply voltage 24 V
- Output 0-10 V DC
- Protection class IP 20

**STK 02 | 168737**



- 3-way ball-valve with actuator 230 V
- With actuator: Control 3-punct or ON/OFF
- Connections internal thread 3/4"
- Temperature range 0 °C...+50 °C

**SEN CO2 02 | 168750**



- Sensor for demand-based volume flow control
- 24 V AC ± 20 %, 15 - 35 V DC or 19 - 29 V AC
- Output 0 - 10 V DC
- Measurement 0 - 2000 ppm CO2

**THE 02 | 168720**

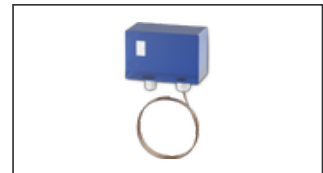

- Frost protection thermostat
- Control range -10 °C...+12 °C, temperature range -10 °C...+55 °C
- Output switching contact 1-pole changeover switch resp. contact
- Capillary length 6 m

**THE 01 | 168724**



- Frost protection thermostat
- Control range -10 °C...+12 °C, temperature range -10 °C...+55 °C
- Output switching contact 1-pole changeover switch resp. contact
- Capillary length 1,8 m

**SEN RH 02 | 172658**



- Humidity sensor
- Humidity 0..100 % rH
- Output 2 x 0-10V
- 15..35Vdc or 19..25Vac

